



---

## RCP-QE User Guide

Version 02

# Thank You for Choosing Ross

You've made a great choice. We expect you will be very happy with your purchase of Ross Technology. Our mission is to:

1. Provide a Superior Customer Experience
  - offer the best product quality and support
2. Make Cool Practical Technology
  - develop great products that customers love

Ross has become well known for the Ross Video Code of Ethics. It guides our interactions and empowers our employees. I hope you enjoy reading it below.

If anything at all with your Ross experience does not live up to your expectations be sure to reach out to us at [solutions@rossvideo.com](mailto:solutions@rossvideo.com).



David Ross  
CEO, Ross Video  
[dross@rossvideo.com](mailto:dross@rossvideo.com)

## Ross Video Code of Ethics

Any company is the sum total of the people that make things happen. At Ross, our employees are a special group. Our employees truly care about doing a great job and delivering a high quality customer experience every day. This code of ethics hangs on the wall of all Ross Video locations to guide our behavior:

1. We will always act in our customers' best interest.
2. We will do our best to understand our customers' requirements.
3. We will not ship crap.
4. We will be great to work with.
5. We will do something extra for our customers, as an apology, when something big goes wrong and it's our fault.
6. We will keep our promises.
7. We will treat the competition with respect.
8. We will cooperate with and help other friendly companies.
9. We will go above and beyond in times of crisis. *If there's no one to authorize the required action in times of company or customer crisis - do what you know in your heart is right. (You may rent helicopters if necessary.)*

# RCP-QE · User Guide

- Ross Part Number: **2201DR-201-02**
- Release Date: March 31, 2016.

The information contained in this Guide is subject to change without notice or obligation.

## Copyright

©2016 Ross Video Limited, Ross®, and any related marks are trademarks or registered trademarks of Ross Video Limited. All other trademarks are the property of their respective companies. PATENTS ISSUED and PENDING. All rights reserved. No part of this publication may be reproduced, stored in a retrieval system, or transmitted in any form or by any means, mechanical, photocopying, recording or otherwise, without the prior written permission of Ross Video. While every precaution has been taken in the preparation of this document, Ross Video assumes no responsibility for errors or omissions. Neither is any liability assumed for damages resulting from the use of the information contained herein.

## Patents

Patent numbers US 7,034,886; US 7,508,455; US 7,602,446; US 7,802,802 B2; US 7,834,886; US 7,914,332; US 8,307,284; US 8,407,374 B2; US 8,499,019 B2; US 8,519,949 B2; US 8,743,292 B2; GB 2,419,119 B; GB 2,447,380 B; and other patents pending.

## Notice

The material in this manual is furnished for informational use only. It is subject to change without notice and should not be construed as commitment by Ross Video Limited. Ross Video Limited assumes no responsibility or liability for errors or inaccuracies that may appear in this manual.

## Important Regulatory and Safety Notices to Service Personnel

Before using this product and any associated equipment, read all the Important Safety Instructions listed below so as to avoid personal injury and to prevent product damage.

Products may require specific equipment, and/or installation procedures be carried out to satisfy certain regulatory compliance requirements. Notices have been included in this publication to call attention to these Specific requirements.

## Symbol Meanings



The exclamation point within an equilateral triangle is intended to alert the user to the presence of important operating and maintenance (servicing) instructions in the literature accompanying the product. Failure to heed this information may present a risk of damage or injury to persons or equipment.



### **Warning**

The symbol with the word “**Warning**” within the equipment manual indicates a potentially hazardous situation, which if not avoided, could result in death or serious injury.



### **Caution**

The symbol with the word “**Caution**” within the equipment manual indicates a potentially hazardous situation, which if not avoided, may result in minor or moderate injury. It may also be used to alert against unsafe practices.

**Notice**

The symbol with the word “**Notice**” within the equipment manual indicates a situation, which if not avoided, may result in major or minor equipment damage or a situation, which could place the equipment in a non-compliant operating state.

**Warning  
Hazardous  
Voltages**

The lightning flash with arrowhead symbol within an equilateral triangle is intended to alert the user to the presence of uninsulated “dangerous voltage” within the product’s enclosure that may be of sufficient magnitude to constitute a risk of shock to persons.

**ESD  
Susceptibility**

This symbol is used to alert the user that an electrical or electronic device or assembly is susceptible to damage from an ESD event.

## Important Safety Instructions

1. Read these instructions.
2. Follow all instructions and heed all warnings.
3. Refer all servicing to qualified service personnel.
4. The equipment’s external power supply AC appliance inlets are the means to disconnect the product from the AC Mains and must remain readily operable for this purpose.
5. To avoid the risk of electrical shock and to completely disconnect the apparatus from the supply AC appliance inlets prior to servicing.
6. The safe operation of this product requires that a protective earth connection be provided. A grounding conductor in the equipment's external power supply line cord provides this protective earth. To reduce the risk of electrical shock to the operator and service personnel, this ground conductor must be connected to an earthed ground.
7. Indoor Use: **WARNING:** To reduce the risk of fire or electric shock, do not expose this apparatus to rain or moisture.
8. **Warning:** This product includes an “Ethernet Port” for connection to a local area network (LAN). This Ethernet port interface is designed for intra-building networks only.

**Warning**

Do not connect this port to networks that go outside of the building.

## EMC Notices

### US FCC Part 15

This equipment has been tested and found to comply with the limits for a class A Digital device, pursuant to part 15 of the FCC Rules. These limits are designed to provide reasonable protection against harmful interference when the equipment is operated in a Commercial environment. This equipment generates, uses, and can radiate radio frequency energy and, if not installed and used in accordance with the instruction manual, may cause harmful interference to radio communications. Operation of this equipment in a residential area is likely to cause harmful interference in which case the user will be required to correct the interference at his own expense.

**Notice**

Changes or modifications to this equipment not expressly approved by Ross Video Ltd. could void the user’s authority to operate this equipment.

### CANADA

This Class “A” digital apparatus complies with Canadian **ICES-003**.

Cet appareil numérique de la classe “A” est conforme a la norme **NMB-003** du Canada.

## EUROPE

This equipment is in compliance with the essential requirements and other relevant provisions of **CE Directive 93/68/EEC**.

## INTERNATIONAL

This equipment has been tested to **CISPR 22:1997** along with amendments **A1:2000** and **A2:2002** and found to comply with the limits for a Class A Digital device.



**Notice** This is a Class A product. In domestic environments, this product may cause radio interference, in which case the user may have to take adequate measures.

## Warranty and Repair Policy

The product is backed by a comprehensive one-year warranty on all components.



**Notice** Changes or modifications to this equipment not expressly approved by Ross Video Limited could void the user's authority to operate this equipment.

If an item becomes defective within the warranty period Ross will repair or replace the defective item, as determined solely by Ross.

Warranty repairs will be conducted at Ross, with all shipping FOB Ross dock. If repairs are conducted at the customer site, reasonable out-of-pocket charges will apply. At the discretion of Ross, and on a temporary loan basis, plug in circuit boards or other replacement parts may be supplied free of charge while defective items undergo repair. Return packing, shipping, and special handling costs are the responsibility of the customer.

This warranty is void if products are subjected to misuse, neglect, accident, improper installation or application, or unauthorized modification.

In no event shall Ross Video Limited be liable for direct, indirect, special, incidental, or consequential damages (including loss of profit). Implied warranties, including that of merchantability and fitness for a particular purpose, are expressly limited to the duration of this warranty.

This warranty is TRANSFERABLE to subsequent owners, subject to Ross' notification of change of ownership.

## Extended Warranty

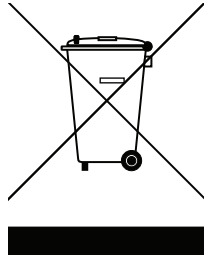
For customers that require a longer warranty period, Ross offers an extended warranty plan to extend the standard warranty period by one year increments. For more information, contact your regional sales manager.

## Environmental Information

The equipment that you purchased required the extraction and use of natural resources for its production. It may contain hazardous substances that could impact health and the environment.

To avoid the potential release of those substances into the environment and to diminish the need for the extraction of natural resources, Ross Video encourages you to use the appropriate take-back systems. These systems will reuse or recycle most of the materials from your end-of-life equipment in an environmentally friendly and health conscious manner.

The crossed-out wheeled bin symbol invites you to use these systems.



If you need more information on the collection, reuse, and recycling systems, please contact your local or regional waste administration.

You can also contact Ross Video for more information on the environmental performances of our products.

## Company Address

### **Ross Video Limited**

8 John Street  
Iroquois, Ontario  
Canada, K0E 1K0

### **Ross Video Incorporated**

P.O. Box 880  
Ogdensburg, New York  
USA 13669-0880

---

General Business Office: (+1) 613 • 652 • 4886

Fax: (+1) 613 • 652 • 4425

Technical Support: (+1) 613 • 652 • 4886

After Hours Emergency: (+1) 613 • 349 • 0006

E-mail (Technical Support): [techsupport@rossvideo.com](mailto:techsupport@rossvideo.com)

E-mail (General Information): [solutions@rossvideo.com](mailto:solutions@rossvideo.com)

Website: <http://www.rossvideo.com>

# Contents

<b>Introduction</b>	<b>1</b>
Overview of this User Guide .....	1-1
<b>RCP-QE Overview</b>	<b>2</b>
Features .....	2-1
Typical System Equipment .....	2-1
System Overview .....	2-2
How the RCP-QE and Routing Switchers Communicate .....	2-3
<b>Installation</b>	<b>3</b>
Unpacking the Equipment .....	3-1
General .....	3-1
Installing the RCP-QE .....	3-1
Accessing the RCP-QE in DashBoard .....	3-3
Checking the Firmware Version .....	3-5
Upgrading the Firmware Version .....	3-5
<b>Setting Up the RCP-QE</b>	<b>4</b>
Implementing Your System Plan .....	4-1
RCP-QE Connection Editor .....	4-2
RCP-QE Connection Editor Field Descriptions .....	4-3
RCP-QE Panel Configuration Editor .....	4-4
RCP-QE Panel Configuration Editor Field Descriptions .....	4-5
Changing Device Details .....	4-9
Default Configuration .....	4-10
Assigning Physical Connections for Control by an RCP-QE .....	4-11
Setting Up Breakaways .....	4-12
Setting Up Menus .....	4-13
Setting Up Button Display Options on the RCP-QE .....	4-14
Assigning Functions to Buttons on the RCP-QE .....	4-15
Assigning a Salvo to a Button .....	4-26
Assigning a Category Index Mode Button .....	4-27
Clearing a Function from a Button .....	4-27
Locking an RCP-QE .....	4-27
Setting Up Machine Control .....	4-28
Linking Remote Control Panels .....	4-29
Setting Up Virtual Routing and Resource Management .....	4-30
Setting the Retry Time for a Switch Failure .....	4-31
Returning to the Home Menu .....	4-31
Loading Factory Defaults Using DashBoard .....	4-32
Saving the Current Configuration for the RCP-QE .....	4-32
Sending a Configuration File to a Device .....	4-33
<b>Operating the RCP-QE</b>	<b>5</b>
LCD Buttons .....	5-1
Breakaways and Levels .....	5-1
Making a Switch .....	5-3
Using a Macro .....	5-4
Using a Salvo .....	5-4

Using Category Index Mode .....	5-4
Locking the RCP-QE .....	5-5
Protecting a Destination .....	5-5
Clearing Protects Held by an RCP-QE .....	5-6
Toggling Between Two Sources .....	5-6
Using a Menu .....	5-7
De-Assigning a Machine Control Port .....	5-7
De-Assigning Resources .....	5-7
Resetting Devices .....	5-8
Viewing Status and Alarms .....	5-8
Operating Linked Remote Control Panels .....	5-8
<b>Troubleshooting</b>	<b>6</b>
<b>RCP-QE Hexadecimal to Router Level Conversion</b>	<b>7</b>



# Introduction

Thank you for purchasing the Ross Video RCP-QE Remote Control Panel. This remote control panel enables you to control a routing switcher system from one point. With Ross Video's reputation for delivering leading-edge routing switcher equipment and our unsurpassed level of customer service and support, you can look forward to many years of reliable broadcasting. Please read this thoroughly and retain it for future reference.

The RCP-QE provides flexible connectivity of additional remote control panels and multi-page menu programming.

## Overview of this User Guide

This guide is for installers and operators of the Ross Video RCP-QE. It provides instructions on how to connect the RCP-QE to your routing switcher system, how to set up a configuration file for the RCP-QE using DashBoard, and how to operate the RCP-QE. It assumes that you are experienced with general broadcast concepts and that you are familiar with the planning requirements for a routing switcher system.



# RCP-QE Overview

## Features

The RCP-QE Remote Control Panel provides the following features:

- 17 programmable buttons (functions, backlighting level, color, and custom text)
  - operation in XY mode
  - up to 32 router levels may be controlled
  - virtual routing and resource management
  - macros
  - custom module in DashBoard for easy creation of configuration files
  - firmware is fully upgradeable using DashBoard
  - slim modular design integrates with NK Series devices via NK-NET Ethernet to T-BUS bridge
  - up to 250 pages of programmable menus including navigation buttons
  - assignable functions of destination, source, crosspoint, level, breakaway, breakaway step, macro, salvo, Category Index Navigation, protect, take, chop, de-assign, machine control, panel lock, menu link, menu navigation, and menu display.
- ★ Category Index Navigation and salvos require the RCP-QE to be connected to an Ultrix router or Ultricore Central Controller.

## Typical System Equipment

The RCP-QE is used when you require advanced control functions from a single point. Using DashBoard, you can program up to 250 menus on the same remote control panel. On each menu, the function of particular buttons may change depending on the assignment. These parameters can be saved in a configuration file and sent to an RCP-QE at any time using DashBoard. Therefore, if an RCP-QE is used in a number of different operating scenarios, the configuration can be changed easily and quickly.

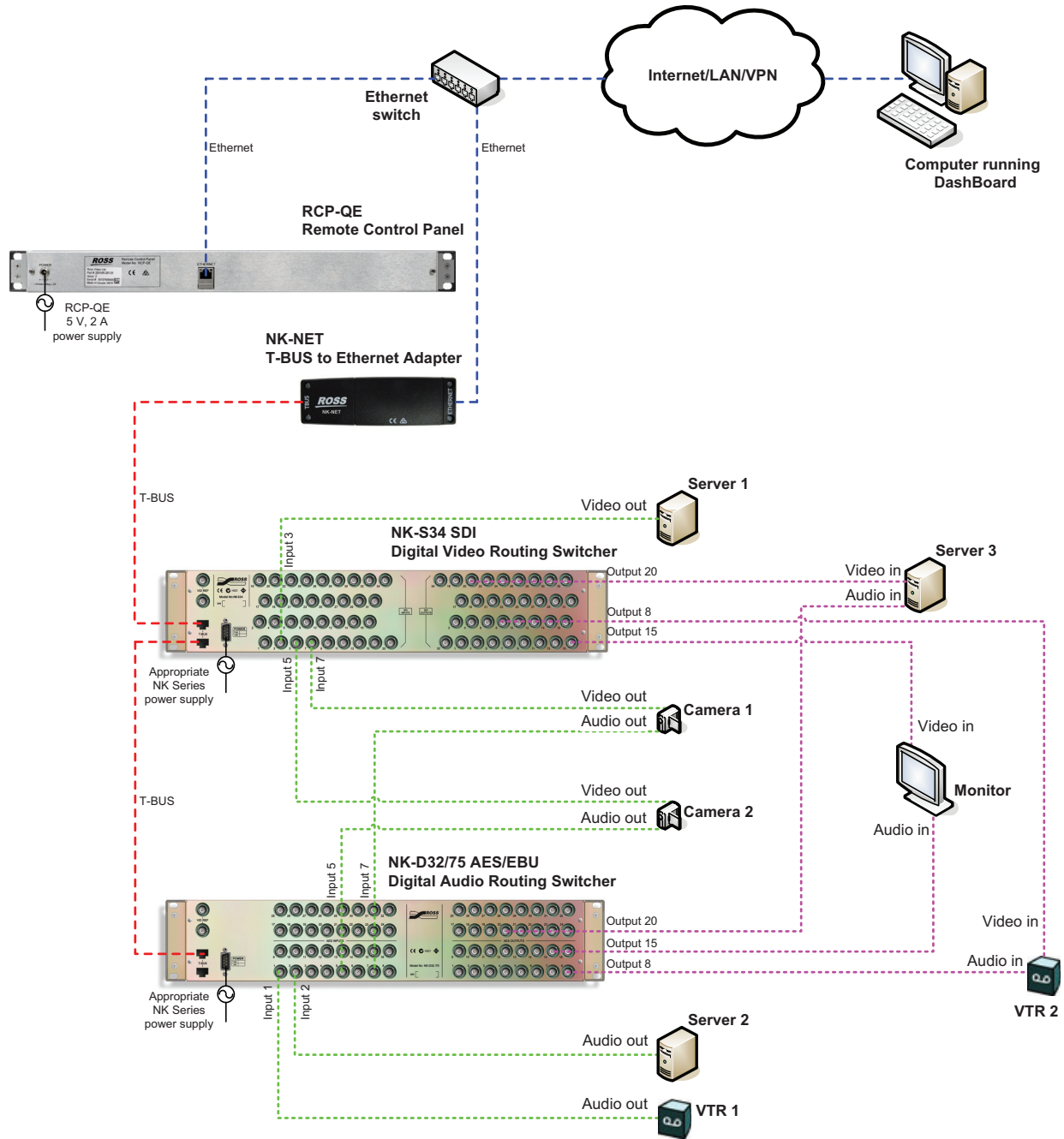
Typical equipment that is used in an NK Series routing switcher system when an RCP-QE is used includes:

- any of the NK Series routing switchers with its appropriate power supply (for more information see the documentation provided with your NK Series routing switcher)
  - an NK-NET, NK-IPS, Ultrix router, or Ultricore Central Controller
  - a computer running DashBoard, connected via a standard CAT5/5e/6 Ethernet cable to the NK-NET
  - standard source and destination equipment (for example, cameras, VTRs, servers)
- ★ If you are connecting the computer directly to the NK-NET, use a standard CAT5/5e/6 Ethernet cable.
- ★ If using an NK-IPS, connecting directly to the NK-IPS is not recommended.

If you are connecting the computer indirectly via an Ethernet switch to the NK-NET, use a standard CAT5/5e/6 Ethernet cable.

## System Overview

A routing switcher system may use distributed control across the internet, a LAN, or a VPN. The routing switcher system shown in **Figure 2.1** has been simplified.



**Figure 2.1** Layout showing a simplified routing switcher system with an RCP-QE

★ All connections use standard CAT5/5e/6 Ethernet cables.

## How the RCP-QE and Routing Switchers Communicate

### Switching

The RCP-QE sends a switch request message through the NK-NET (or NK-IPS) to the routing switcher. The routing switcher recognizes the request, sets the crosspoint, and then sends a response through the NK-NET (or NK-IPS) to the RCP-QE.

### Data Storage

The RCP-QE stores information on the menu, destination, level, breakaway, and machine control status. The routing switcher stores the crosspoint status in its internal memory.

When the routing switcher system is powered up, the routing switcher restores its crosspoint status. The RCP-QE requests the status of the routing switcher. The routing switcher sends the status of the crosspoints to the RCP-QE.



# Installation

## Unpacking the Equipment

On receiving your RCP-QE, check the contents against the packing list. Before you start installing the RCP-QE into your system, ensure that all equipment itemized on the packing list is present and that there are no signs of damage.

If anything is missing or damaged, contact your Ross Video office immediately to obtain the correct warranty service procedures. This ensures prompt assistance, minimal turnaround time, and avoids any freight issues.

We recommend that the equipment is installed to any relevant standards and approvals by qualified and experienced personnel.

## General

These installation guidelines assume the following:

- The relevant NK Series equipment has been installed into a ventilated rack frame. The relative humidity in the environment of the equipment should be < 70% (non-condensing).
- The routing switcher system has been well planned and designed. Consideration must be given to inputs and outputs across multiple router levels and typical operating scenarios for breakaways.
- Where required, correct IP addresses have been assigned to the equipment.
- The routing switchers are connected to physical inputs and outputs and have appropriate power supplies.

## Installing the RCP-QE

The RCP-QE is powered using the 5 V 2 A power supply provided. This power supply connects directly to the AC mains supply.



---

**Warning** — *Ensure that the AC mains supply complies with the PSU specification before making the connection.*



---

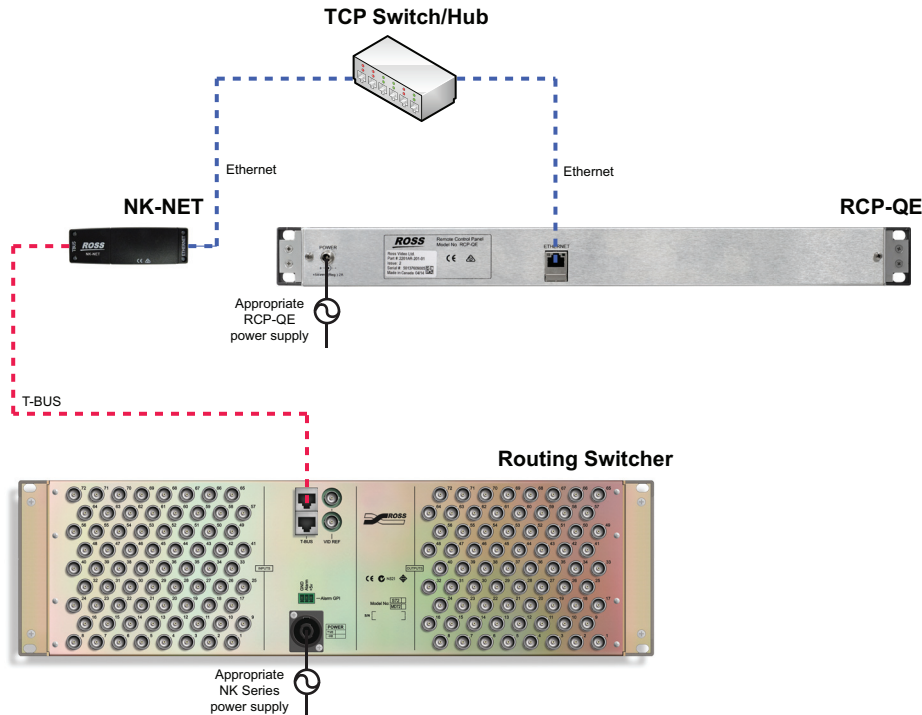
**Warning** — *An earthed neutral mains supply and residual current device is recommended for safe operation.*

---

## Installing the Routing Switcher System

The RCP-QE uses a TCP network for connection. It connects to the T-BUS routing devices using either the NK-NET or the NK-IPS. The NK-NET receives phantom power from the T-BUS devices to which it is connected. If the device providing power loses power, the NK-NET loses power as well.

- ★ The RCP-QE can have up to three more NK-NETs configured as backups in the event that connection is lost to the primary NK-NET.



**Figure 3.1** RCP-QE connected within an NK routing system

### To connect the remote control panel in the routing system:

1. Place the RCP-QE into the rack frame and then fix in place with appropriate fasteners.
  2. Connect a standard CAT5/5e/6 Ethernet cable to the **ETHERNET** connector on the rear of the RCP-QE.
  3. Connect the other end of the standard CAT5/5e/6 Ethernet cable to the network TCP switch/hub.
  4. Connect another standard CAT5/5e/6 Ethernet cable to the network TCP switch/hub.
  5. Connect the other end of the standard CAT5/5e/6 Ethernet cable to the **ETHERNET** connector on the NK-NET.
  6. Connect a standard CAT5/5e/6 Ethernet cable to the **T-BUS** connector on the NK-NET.
  7. Connect the other end of the standard CAT5/5e/6 Ethernet cable to the **T-BUS** connector on the rear of any NK device that is connected by T-BUS to an NK Series router (including the router itself).
- ★ The NK device(s) must be powered up when the system is connected in order to provide phantom power to the NK-NET.
  - 8. Connect the 5 V 2 A power supply provided to the **POWER** connector on the rear of the RCP-QE.
  - 9. Connect the cable from the power supply to a suitable AC mains supply.
  - ★ The RCP-QE is designed for installation into a standard 19" equipment rack. It has integrated rack ears, allowing it to be screwed in using standard screws and cage nuts.



## Accessing the RCP-QE in DashBoard

Before you can set up and send a configuration file to the RCP-QE, you must access it in DashBoard. In order to access the RCP-QE in DashBoard, the RCP-QE needs to be detected and the IP address for the LAN configured for use within a network using Walkabout. Once the network settings are configured in Walkabout, the RCP-QE is visible in DashBoard and can have the device details configured and a configuration file sent to it.

### Installing DashBoard

Download DashBoard at <http://www.rossvideo.com/> and follow the installation instructions.

Ensure that DashBoard has all the latest module updates before proceeding.

#### For More Information on...

- updating DashBoard see the DashBoard on-line help.

### Adding an RCP-QE to DashBoard

The RCP-QE can be added to DashBoard via automatic discovery or manually using The NK-IPS Connection window.

#### Adding an RCP-QE to DashBoard via Automatic Discovery

The RCP-QE can be detected in DashBoard using auto discovery via SLP once the IP address for the LAN has been configured for use within a network using Walkabout.

#### To add an RCP-QE to DashBoard:

1. Open **Walkabout**.

If necessary, click **Refresh** to query the network for RCP-QE devices.

2. Locate the RCP-QE you want to add to DashBoard and configure the following information if necessary:

- **Name** – double click inside the cell to enter a name for the RCP-QE.  
The default is RCP-QE.
- **Address** – double click inside the cell to enter an IP address for the RCP-QE.  
The default is 192.168.20.130.
- **Netmask** – double click inside the cell to enter an IP netmask for the RCP-QE.  
The default is 255.255.255.0.
- **Gateway** – double click inside the cell to enter an IP gateway for the RCP-QE.  
The default is 192.168.20.1.

3. Open **DashBoard**.

4. Refresh the **Basic Tree View**.

The RCP-QE is added to the devices listed in the **Basic Tree View**.

#### Manually Adding an RCP-QE to DashBoard

RCP-QE can be added manually to DashBoard by entering its IP address using the NK-IPS Connection window once it has been configured for use within a network using Walkabout.

#### To manually add an RCP-QE to DashBoard:

1. Open **Walkabout**.

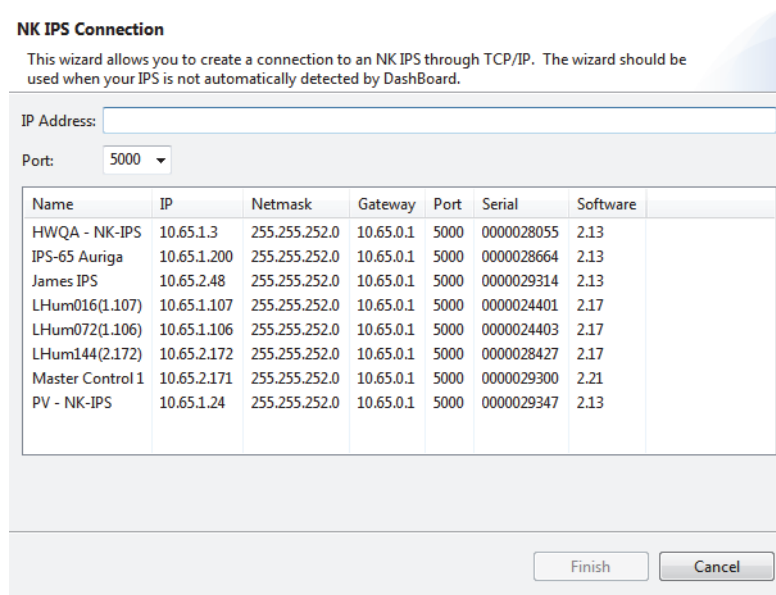
If necessary, click **Refresh** to query the network for RCP-QE devices.

2. Locate the RCP-QE you want to add to DashBoard and configure the following information if necessary:

- **Name** – double click inside the cell to enter a name for the RCP-QE.  
The default is RCP-QE.
- **Address** – double click inside the cell to enter an IP address for the RCP-QE.  
The default is 192.168.20.130.
- **Netmask** – double click inside the cell to enter an IP netmask for the RCP-QE.  
The default is 255.255.255.0.
- **Gateway** – double click inside the cell to enter an IP gateway for the RCP-QE.  
The default is 192.168.20.1.

3. In **DashBoard**, click **File > New > NK-IPS Connection**.

The **NK-IPS Connection** window opens.



**Figure 3.2** The NK-IPS Connection window

4. In the **IP Address** box, enter the IP address of the RCP-QE you want to add to DashBoard.

5. Use the **Port** list to select a port number.

The default is 5000. If the port number is changed in Walkabout, the port number in the NK-IPS Connection window must be configured to reflect this change.


6. Click **Finish**.

The **NK-IPS Connection** window closes and the RCP-QE is added to the devices listed in the **Basic Tree View**.

## Checking the Firmware Version

Firmware may be updated easily using DashBoard. To check for the latest firmware versions, contact Ross Video Technical Support.


### To check the firmware version of a device using DashBoard:

1. Open **DashBoard**.
2. In the **Basic Tree View**, double-click the **Connection** icon (  RCP-QE 2 ) within the device tree (RCP-QE 2 in the icon is a name used for example purposes).  
The **Connection** editor opens.  
The firmware version is shown in the **Version** field in the general information area.

## Upgrading the Firmware Version

Firmware upgrade files can be obtained by contacting Ross Video Technical Support.

### To upgrade the RCP-QE firmware:

1. Open **DashBoard**.
2. In the **Basic Tree View**, double-click the **Connection** icon (  RCP-QE 2 ) within the device tree (RCP-QE 2 in the icon is a name used for example purposes).  
The **Connection** editor opens.
3. Click **Send Firmware**.  
The **Open** file browser opens.
4. Navigate to where you have stored the firmware file and select it.
5. Click **Open**.  
The **Confirm Upload** dialog box opens.
6. Click **Continue**.  
A progress bar is displayed. When the upload has completed, a confirmation box opens.
7. Click **OK**.
8. Click **Reboot** to restart the device and activate the new firmware.



# Setting Up the RCP-QE

The RCP-QE panel can be set up using DashBoard. You must have an NK-NET, NK-IPS, or Ultracore Central Controller connected to the T-BUS system to connect to NK Series devices.

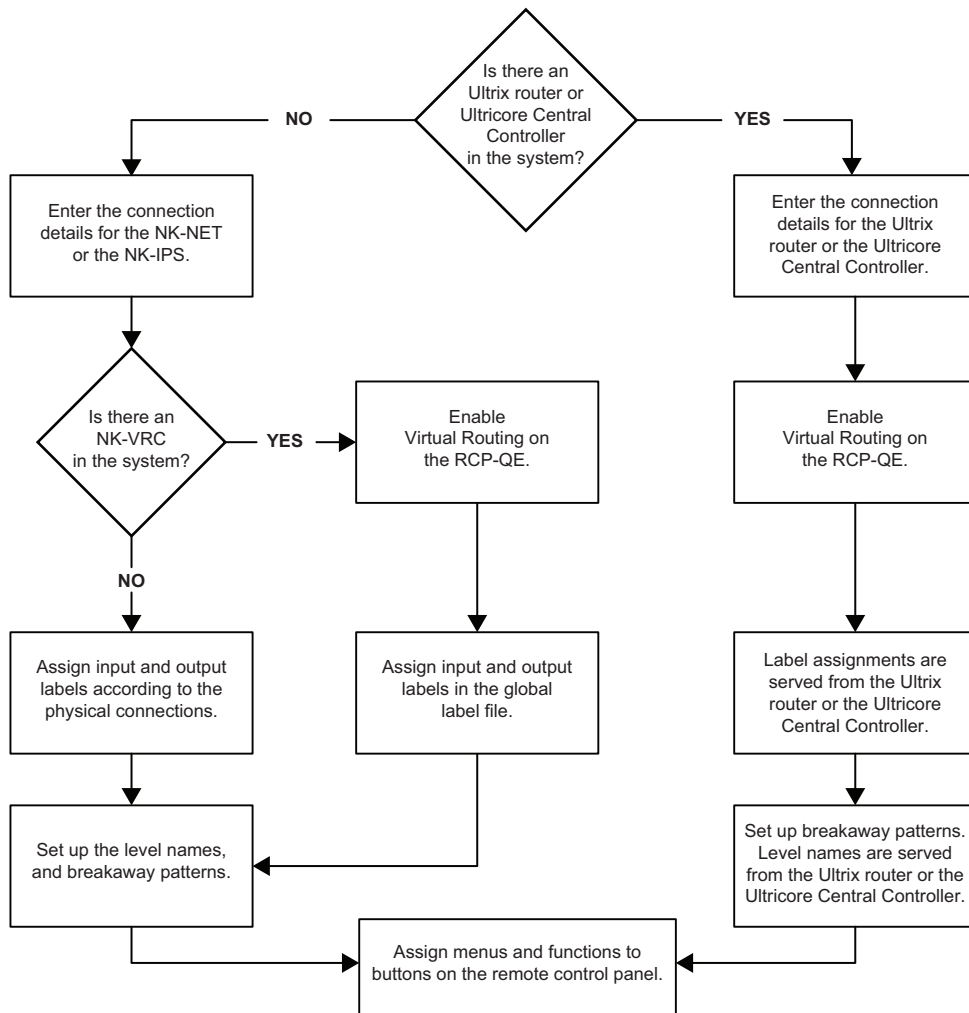
The parameters for a device can be saved to a configuration file.

## For More Information on...

- checking and upgrading firmware, see “**Checking the Firmware Version**” on page 3–5 and “**Upgrading the Firmware Version**” on page 3–5.
- saving parameters to a configuration file, see “**Saving the Current Configuration for the RCP-QE**” on page 4–32.

## Implementing Your System Plan

An effective routing system takes careful planning. If you intend to use multiple router levels across several input and output devices, it is recommended that you use common input connectors for each source device across the routing switchers, and common output connectors for each destination device across the routing switchers. This methodology is shown in **Figure 4.1**. The following process for setting up the RCP-QE is recommended.



**Figure 4.1** Flow chart for setting up the RCP-QE

## RCP-QE Connection Editor

The RCP-QE Connection Editor enables users to configure the device details, such as the name and group, the network settings, and the server connections.

### Opening the RCP-QE Connection Editor

To open the RCP-QE Connection Editor:

1. In **DashBoard**, expand the tree view for the RCP-QE in the **Basic Tree View**.

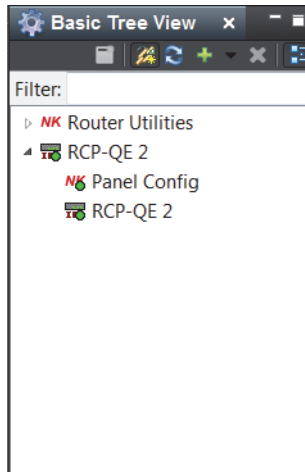



Figure 4.2 Basic Tree View in DashBoard

2. Double-click the **Connection** icon (  RCP-QE 2 ) within the device tree.

The **Connection Editor** opens.

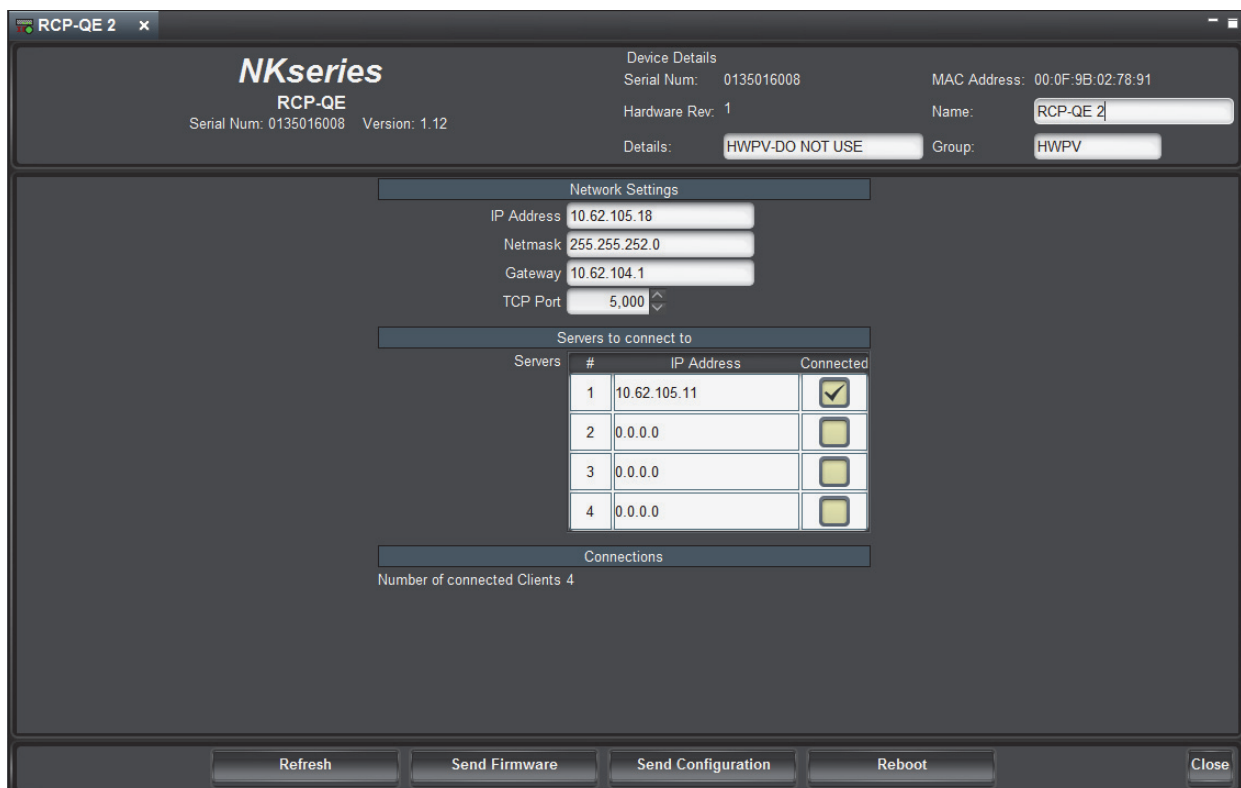


Figure 4.3 The RCP-QE Connection Editor tab in DashBoard

# RCP-QE Connection Editor Field Descriptions

## General

**Serial Num** (read-only) – the serial number is set in the factory before shipping and is unique to each device. This parameter is not user configurable.

**Version** (read-only) – the software/firmware version.

## Device Details

**Serial Num** (read-only) – the serial number is set in the factory before shipping and is unique to each device. This parameter is not user configurable.

**Hardware Rev** (read-only) – the hardware version of the RCP-QE.

**Details** – assigned by the user to give an RCP-QE specific details. For example, a physical location or a brief description of its use.

This field has a maximum of 16 characters and is used for description and identification only.

**MAC Address** (read-only) – the Media Access Control address (MAC address) is the unique hardware address for the RCP-QE on a network. This parameter is not user configurable.

**Name** – this field can be assigned by the user to uniquely name an RCP-QE.

This field has a maximum of 16 characters and is used for description and identification only.

**Group** – a group number can be assigned by the user to organize devices into groups. For example, users can assign separate group numbers for devices in different physical areas.

This field has a maximum of 10 characters and by default is blank.

## Network Settings

★ Newly assigned IP addresses and netmasks are checked for valid values before being applied to an RCP-QE. If the new values are invalid they will be discarded silently. Only a refresh of the RCP-QE Connection Editor will show that the values were not set.

**IP Address** – enter or edit the IP address of the device.

**Netmask** – enter or edit the IP netmask of the device.

**Gateway** – enter or edit the IP gateway of the device.

**TCP Port** – enter or select the Transmission Control Protocol port number used for network communication. By default, the TCP Port is 5000, and any client devices/apps should be setup with the same port number.

## Servers to Connect to

# – the order priority of the servers.

**IP Address** – the IP address of the server.

**Connected** (read-only) – a selected check box indicates that there is a connection to the server. An unchecked box indicates that there is no connection.

## Connections

Displays the number of clients connected to the RCP-QE.

## Toolbar Buttons

**Refresh** – click this button to revert to the configuration previously sent to the RCP-QE. The RCP-QE Connection Editor will display the last settings that were sent to the RCP-QE via the Send Configuration button.

**Send Firmware** – click this button to open a file browser to select a software/firmware file to send to the RCP-QE.

**Send Configuration** – click this button to upload the settings to the RCP-QE.

★ All configuration items become active only after uploading by sending the configuration to the device.

**Reboot** – click this button to reboot the RCP-QE. This function does not clear the RCP-QE settings.

**Close** – click this button to close the RCP-QE Connection Editor in DashBoard.

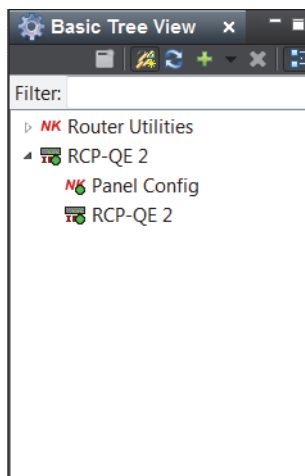
## RCP-QE Panel Configuration Editor

The RCP-QE Panel Configuration editor enables users to setup device details, panel button assignments, menus, I/O assigns, and macros.

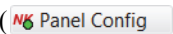
### Opening the RCP-QE Panel Configuration Editor

To open the RCP-QE Panel Configuration editor:

1. In **DashBoard**, expand the tree view for the RCP-QE in the **Basic Tree View**.

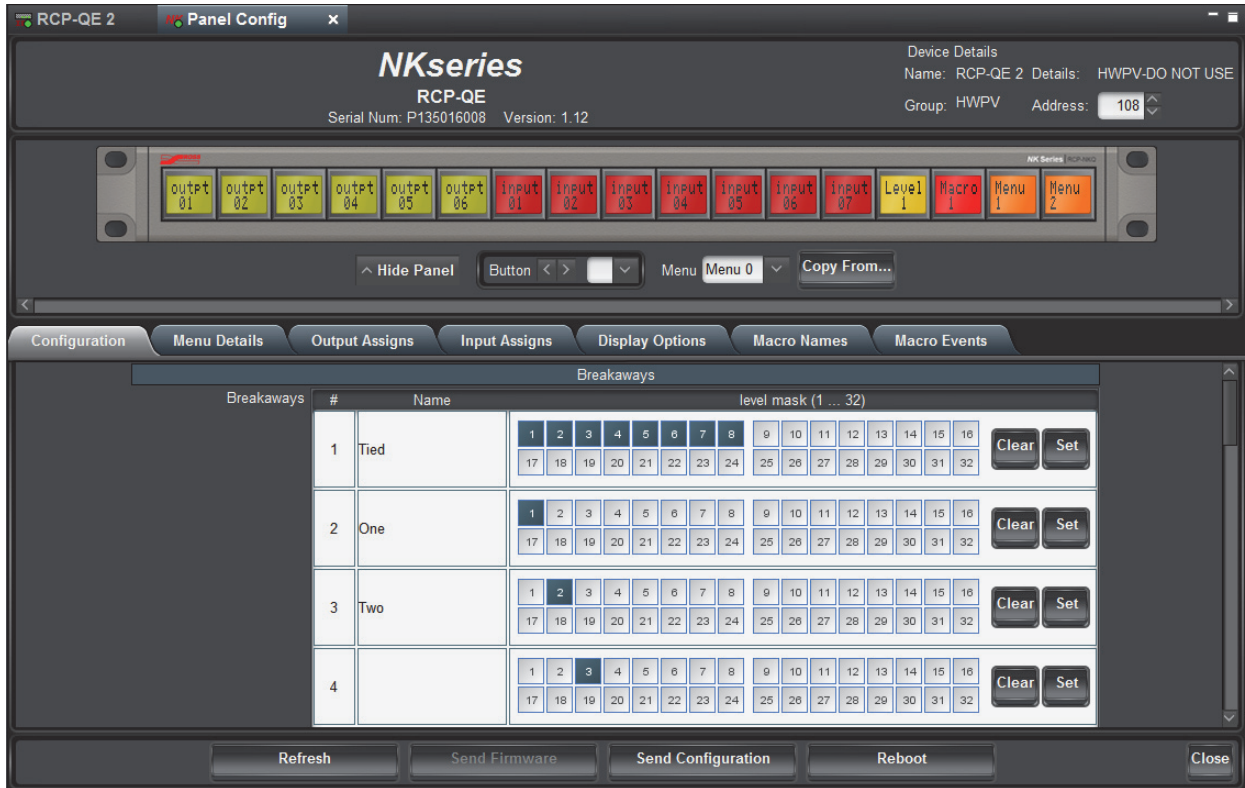


*Figure 4.4 Basic Tree View in DashBoard*

2. Double-click the **Panel Config** icon (  ) within the device tree.



The **Panel Configuration** editor opens.



**Figure 4.5** The RCP-QE Panel Configuration editor tab in Dashboard

## RCP-QE Panel Configuration Editor Field Descriptions

### General

**Serial Num** (read-only) – the serial number is set in the factory before shipping and is unique to each device. This parameter is not user configurable.

**Version** (read-only) – the software/firmware version.

### Device Details

**Name** – this field can be assigned by the user to uniquely name an RCP-QE.

This field has a maximum of 16 characters and is used for description and identification only.

**Group** – a group number can be assigned by the user to organize devices into groups. For example, users can assign separate group numbers for devices in different physical areas.

This field has a maximum of 10 characters and by default is blank.

**Details** – assigned by the user to give an RCP-QE specific details. For example, a physical location or a brief description of its use.

This field has a maximum of 16 characters and is used for description and identification only.

**Address** – this address is used within the overall control system to identify NK devices using resource management and protects. Each device must be given a unique T-BUS address to avoid communication conflicts<sup>1</sup>.

The valid value range for assigning an individual device T-BUS address is 1-255.

---

1. Except when panel-linking is used.

## Simulated RCP-QE Panel

**Inputs/Outputs** – source/destination buttons. Click a button to open the **Button** menu to assign a function to the button.

**Hide Panel** – click this button to hide the simulated RCP-QE panel.

**Button** – click the arrow buttons to select a button from the panel or use the list to select a specific button.

**Menu** – use the list to select a specific menu configuration for the panel.

**Copy From** – click this button to open the **Copy Menu From** dialog box to select a menu configuration to copy.

## Configuration Tab

### Panel Link Address

Two or more remote control panels may be linked to form a larger physical panel. This is known as panel linking. Panels are linked when they have the same master address (as specified in the section “**To change the details for the RCP-QE:**” on page 4–9) and different panel link addresses.

### Breakaways

# (read-only) – the list number of the breakaway.

**Name** – the name assigned for the breakaway. The names are user configurable.

**Level Mask (1...32)** – click a router level to assign a level mask (level mask selected: ) or de-select a level mask (level mask de-selected: )

**Clear** – click this button to clear all level masks for a given breakaway.

**Set** – click this button to apply all selected level masks for a given breakaway.

### Configuration

**Breakaway Reset** – select this check box to return to the default breakaway after every switch. The default is Breakaway 1.

**Breakaway Warning Mode** – use the list to select a breakaway warning mode:

- **Current** – if there is a level mismatch compared to the current breakaway, a breakaway warning is shown when displaying the status.
- **Default** – if there is a level mismatch compared to the default breakaway (Breakaway 1), a breakaway warning is shown when displaying the status.

**Panel Locked** – select this check box to lock the panel buttons.

**Machine Control Enabled** – select this check box to use machine control to provide reciprocal switching of RS-422 signals.

**Machine Control Level** – enter or select a router level for machine control.

**Virtual Routing Enabled** – select this check box to enable virtual routing. Virtual routing requires an NK-VRC in an NK series router system.

★ Virtual routing must be enabled for the RCP-QE to function with an Ultrix router or Ultricore Central Controller.

**Comms Retry Delay Factor** – enter or select a retry delay factor in milliseconds. Systems require different retry times depending on the transfer of requests and responses between modules. A value of 50ms is a recommended default.

**Protect Mode** – select a radio button to assign a protect mode to the panel:

- **Block Other Panels** – the protected destination and level(s) cannot be switched to another source by other remote control panels.  
The protected destination and level(s) can be switched to another source on the current remote control panel.
- **Block All Panels** – the protected destination and level(s) cannot be switched to another source by the current remote control panel or other remote control panels.

**Clear Protect(s)** – select this check box to clear all protects from the panel.

**Return to Home Menu** – select this check box to return the panel to its home menu configuration.

**Load Factory Defaults** – select this check box to load the factory defaults of the panel.

★ All configuration items become active only after uploading by sending the configuration to the device.

## Alarms

**Protect** (read-only) – the protect alarm can display the following statuses:

- **No Protect** (green) – indicates that there is no crosspoint protect enabled on the panel.
- **Protect(s)** (yellow) – indicates that a crosspoint protect is enabled on the panel.

**For More Information on...**

- protects, refer to “**Assigning a Protect Button**” on page 4–23.
- crosspoints, refer to “**Assigning a Crosspoint Button**” on page 4–18.

## Menu Details Tab

### Menu Details

**Number of menus** – enter or select a number of menus to use for the panel.

**Update** – click this button to update the amount of menus used for the panel.

**Menu Number** (read-only) – the list order number of the menu.

**Menu Name** – click inside the table cell to enter or edit a name for the selected menu.

**Fallback Mode** – click inside the table cell to use the list to select the fallback mode for the menu:

- **Fallback Off** – after a button in the menu is pressed, the RCP-QE remains on the menu the panel is currently on.
- **First Menu** – after a button in the menu is pressed, the RCP-QE returns to Menu 1.
- **Previous Menu** – after a button in the menu is pressed, the RCP-QE returns to the menu that was active prior to the current menu.
- **Specified Menu** – after a button in the menu is pressed, the RCP-QE returns to the menu specified in the **Fallback Menu** column.
- **Fallback Menu** – if using Specified Menu as the fallback mode, click inside the table cell to enter a menu number to return to after a button is pressed.

**Menu Color** – click inside the table cell to use the list to select a button color for the menu button.

## Output/Input Assigns Tab

★ If the RCP-QE is configured to connect to an Ultrix router or Ultricore Central Controller, the output and input assignments are managed from those devices. Any editing on the RCP-QE tabs will be overwritten. You can use the Database to RCP button on the Network tab in the Ultrix/Ultricore interfaces to load input/output/level assignments to the RCP-QE panel.

## Output/Input Assigns

**Number of outputs/inputs (increments of 8)** – enter or select a number of outputs/inputs. The number must be changed in increments of eight.

**Update** – click this button to update the output/input assigns.

**Copy to Input/Output Assigns** – click this button to transfer the number of outputs/inputs to the other assigns tab. The labels are imported as well.

**Import Global Labels** – click this button to import global labels for the outputs/inputs.

**Output/Input Range** – use this list to select the range of outputs/inputs to view in the Output/Input Assigns. The assigns tab will only display the I/O ranges in blocks of 120 outputs/inputs at a time, with each block selectable in the range list.

**Out/In** (read-only) – the output/input number.

**Label** – click inside the table cell to edit or enter a name for the output/input. If you have configured global labels, the labels can also be filled in by clicking the **Import Global Labels** button.

## Display Options

**Mode** – the type of button function.

**Default Color** – click inside the table cell and use the list to select a color for the button when it is not selected or active.

**Invert Default** – select the check box to invert the text on the button when it is not selected or not active.

**Selected Color** – click inside the table cell and use the list to select a color for the button when it is selected or active.

**Invert Selected** – select the check box to invert the text on the button when it is selected or active.

★ Use the simulated button examples on the right side of the table to view the currently selected button display configuration.

## Macro Names

# (read-only) – the macro number.

**Name** – click inside the table cell to enter a name for the macro.

## Macro Events Tab

**Macro #** (read-only) – the macro number.

**Num. Rows** – enter or select the number of event rows to add to the macro.

**Update** – click this button to update the macro with the number of rows entered in the **Num. Rows** box.

**Event** (read-only) – the macro event number. Triggering the macro will trigger events in this order.

**Function** – use the list to select a function to perform with the macro:

- **Switch** – performs a standard crosspoint switch.
- **Macro** – performs a macro within the executed macro.
- **Protect** – creates a protect condition on the destination of the selected crosspoint.

**Output** – click inside the table cell to enter or edit the destination output.

**Input** – click inside the table cell to enter or edit the source input.

**Level Mask (1...32)** – select the level mask(s) for the device affected by the macro.

**Clear** – click to clear the level mask(s).

**Set** – click to set the level mask(s).

## Salvo Names Tab

★ Only applicable when the routing system includes an Ultrix router or Ultracore Central Controller.

**Salvo #** (read-only) – the list order number of the salvo.

**Name** (read-only) – the name of the salvo as defined in connected Ultrix router or Ultracore Central Controller.

**Enabled** – enable or disable this salvo within Category Index mode.

## Level Names Tab

★ Only applicable when the routing system includes an Ultrix router or Ultracore Central Controller.

**#** (read only) – the list order number of the level name entry.

**Name** (read-only) – the name of the Level as defined in connected Ultrix router or Ultracore Central Controller.

**Enabled** – enable or disable this salvo within Category Index mode.

## Destination / Source Label Access

Enables destinations or sources to be enabled or disabled for button assignment.

**#** (read only) – the list order number of the label entry.

**Label** (read-only) – the name of the Label as defined in connected Ultrix router or Ultracore Central Controller.

**Enabled** – enable or disable this destination or source within Category Index mode.

## Lower Toolbar Buttons

**Refresh** – click this button to revert to the configuration previously sent to the RCP-QE. The RCP-QE Connection Editor will display the last settings that were sent to the RCP-QE via the Send Configuration button.

**Send Configuration** – click this button to upload the settings to the RCP-QE. All configuration items become active only after uploading.

**Reboot** – click this button to reboot the RCP-QE. This function does not clear the RCP-QE settings.

**Close** – click this button to close the RCP-QE Connection Editor in DashBoard.

## Changing Device Details

When a control panel is attached to the network, it is interrogated and an editor for the device can be opened in the main pane of DashBoard (see **Figure 4.5**). Information is read from the device and shown in the simulated RCP-QE.

### To change the details for the RCP-QE:

1. In the **Device Details** frame, click inside the field that you want to change.
2. Enter the information as required.
3. Press **Enter**.
4. Send the current configuration file to the device (see “**Sending a Configuration File to a Device**” on page 4–33).

★ You should save the current configuration file regularly (see “**Saving the Current Configuration for the RCP-QE**” on page 4–32).

## Default Configuration

Every panel leaves the factory with a default configuration. This default configuration is viewed by opening the editor tab for the device in DashBoard.

## Loading Default Configuration

Best practice is to save the default configuration to an \*.cbd file after opening the Connection Editor and Panel Configuration editor in DashBoard for the first time. If you have made changes to the configuration but want to return to the default configuration, you can send the saved default configuration file to the device (see “**Sending a Configuration File to a Device**” on page 4–33). You can also load the factory defaults (see “**Loading Factory Defaults Using DashBoard**” on page 4–32).

## Router Levels

Routers are set up using levels (or layers) to enable individual or concurrent switching over many different signal formats. Levels are an element of the control system used to identify certain routers (or parts thereof). Often individual layer assignments are given to different signal types (e.g. SDI would be one layer, analog audio would be a second layer etc.).

The RCP-QE sends switch requests to the routing switcher, or to an Ultrix router or an Ultricore Central Controller (if one is present in the system). Each routing switcher is assigned a default level from the factory (or number of levels if it has been partitioned). These level assignments can be changed through the Panel Configuration editor tab in DashBoard.

**Table 4.1 Default NK Series Router Levels**

Router Level	Name
1	Multi-definition 3G/HD/SD SDI digital video
2	SD SDI digital video
3	AES/EBU digital audio 1
4	AES/EBU digital audio 2
5	Analog video
6	Analog audio (left)
7	Analog audio (right)
8	Machine control

★ When the RCP-QE is connected to an Ultrix router or Ultricore Central Controller, the level names will be overwritten with data from the Ultrix or Ultricore.

## Breakaways

Breakaways are groups of levels. Traditionally the default breakaway is the all levels (or TIED). The default RCP-QE TIED breakaway is the first eight levels (this may be edited). The first eight router levels are switched together when requested from the RCP-QE. If your routing switcher system does not use all of the router levels, you should remove the unused levels from the default breakaway. For more information on breakaways see “**Setting Up Breakaways**” on page 4–12.

## Button Assignments

By default, the 17 buttons on the RCP-QE are assigned the following functions:

- buttons 1 to 6: destinations (outputs 1 to 6, respectively)
- buttons 7 to 13: sources (inputs 1 to 7, respectively)
- button 14: Level 1
- button 15: Macro 1
- button 16: Menu 2
- button 17: Menu 3

## Assigning Physical Connections for Control by an RCP-QE

Source and destination equipment is physically connected to routing switchers. This connection information must be displayed meaningfully on the RCP-QE. This information is set up on the **Input Assigns** and **Output Assigns** tabs.

### Selecting the Number of Outputs/Inputs

Depending on the size of the routing switchers connected, you may choose to increase or reduce the number of output and input labels to match the size of the routing switcher if virtual routing is not used. The number can be changed in increments of 8.

- ★ If the RCP-QE is connected to an Ultrix router or Ultricore Central Controller, the number of inputs and outputs are defined by the Ultrix/Ultricore set up. Changes to Ultrix or Ultricore will overwrite any manual changes made on the remote control panel.

#### To change the number of possible inputs and outputs:

1. Open the RCP-QE Panel Configuration editor (see “**Opening the RCP-QE Panel Configuration Editor**” on page 4–4).
2. Perform one of the following:
  - To change the number of outputs, select the **Output Assigns** tab.
  - To change the number of inputs, select the **Input Assigns** tab.
3. Use the **Number of outputs/Number of inputs** box to enter or select the number of outputs/inputs to match the requirements of your routing switcher system.
4. Click **Update**.
5. If you want to transfer this number of outputs/inputs to the other tab, click **Copy to Input Assigns/Copy to Output Assigns**. The labels are also copied.
6. Send the current configuration file to the device (see “**Sending a Configuration File to a Device**” on page 4–33).

### Assigning Output and Input Labels

#### To assign output and input labels:

1. Open the RCP-QE Panel Configuration editor (see “**Opening the RCP-QE Panel Configuration Editor**” on page 4–4).
2. Perform one of the following:
  - To change the label for an output, select the **Output Assigns** tab.
  - To change the label for an input, select the **Input Assigns** tab.

3. Click to highlight the text in the **Label** column corresponding to the output/input to which the item of destination/source equipment is connected.
4. Enter the name of the item of destination/source equipment.
5. Press **Enter**.

The name of the item of destination/source equipment appears on the corresponding button on the simulated RCP-QE in DashBoard.

6. Repeat step 1 to 5 until all of the outputs and inputs on the routing switchers have been assigned a label for the connected destination and source equipment.
7. If you want to transfer the labels for the outputs/inputs to the other assigns tab, click **Copy to Input Assigns/Copy to Output Assigns**.

The number of outputs/inputs is also copied.

8. Send the current configuration file to the device (see “**Sending a Configuration File to a Device**” on page 4–33).

- ★ If there are various router levels using this output or input number, the label may be ambiguous if the destination or source is different for those levels.

You may rearrange the layout of the labels on the buttons when you assign functions to the buttons (see “**Assigning Functions to Buttons on the RCP-QE**” on page 4–15).

## Setting Up Breakaways

A breakaway selects a group of levels to be switched. The default breakaway for the RCP-QE is the first eight router levels switching together (they are tied). If your routing switcher system does not use all of the predefined router levels (see **Table 4.1**), you should disable those levels that are not used in order to prevent a breakaway warning. If you only want to switch certain router levels, set up a custom breakaway for these levels and then assign this to a button on the RCP-QE (see “**Assigning Functions to Buttons on the RCP-QE**” on page 4–15). If you select a breakaway that includes a level for which there is no routing switcher assigned, a breakaway warning is indicated by three bars (|||) in the bottom right corner of the button on the panel.

- ★ If the RCP-QE is connected to an Ultrix router or Ultricore Central Controller, the level numbers for setting breakaway pattern correspond to the **ID** column within the Ultricore **Levels** tab.

### To set up the breakaways:

1. Open the RCP-QE Panel Configuration editor (see “**Opening the RCP-QE Panel Configuration Editor**” on page 4–4).
2. Select the **Configuration** tab.
3. In the **Tied** level mask of the **Breakaways** section, de-select the router levels that are not used in your routing switcher system by clicking on the numbered squares. A selected router level is indicated by a blue square.

For example, if router levels 2 and 3 are the only levels used, you should de-select levels 1, 4, 5, 6, 7, and 8 in the **Level Mask** column corresponding to **Tied**.

The **Tied** breakaway is the default. It is breakaway # 1 in the table.

4. Double-click inside the **Name** column in the breakaway (# 2) below **Tied**.
5. Enter a name for the router level that corresponds to the first custom breakaway that you want to define.  
For example, enter **SDI**.
6. Select the corresponding router level(s) in the **Level Mask** column (see **Table 4.1**), and de-select any router levels that are not used.
7. Define the next custom breakaway in the **Name** column below the breakaways that you have defined previously. Repeat steps 3 to 7 until you have defined all the custom breakaways that you want to use.



8. Clear the remaining level masks from unused breakaways in the **Breakaways** table.
  9. In the **Configuration** section, use the **Breakaway Warning Mode** list to select the breakaway with which you want to compare the status of the router levels in the current breakaway.
  10. Send the current configuration file to the device (see “**Sending a Configuration File to a Device**” on page 4–33).
- ★ If you change the level pattern in DashBoard, a breakaway button must be pressed on the panel for the new level assignment to take effect.
  - ★ If you click and drag across the level mask, you can rapidly select or de-select router levels.

The breakaway defined in the first row of the **Breakaway** table is the default breakaway.

You can combine more than one router level in the same breakaway. Give the breakaway a meaningful name that covers the router levels that you want to use. Limit the name to 8 characters.

A breakaway warning is caused when there is no response from the routing switcher system on one or more router levels, or a difference in status of any level in the currently selected breakaway when compared with the first level in the breakaway

The default breakaway and any custom breakaways can now be assigned to buttons on the RCP-QE

#### For More Information on...

- sending the current configuration file to the device, see “**Sending a Configuration File to a Device**” on page 4–33.
- assigning breakaways to buttons, see “**Assigning a Breakaway Button**” on page 4–20.

## Automatically Resetting a Custom Breakaway to the Default Breakaway After a Switch

The default breakaway is defined in the first row of the **Breakaways** table in the **Breakaways** section. Typically, this breakaway is tied and it switches all router levels together. If you want only certain router levels to switch as defined in a custom breakaway, select that breakaway on the RCP-QE and then make the switch. The RCP-QE continues to use that breakaway (as indicated by the button being illuminated) for all further switches until another custom breakaway or the default breakaway is selected. If you want the RCP-QE to reset to the default breakaway immediately after a custom breakaway is used during a switch, then you should set the RCP-QE to reset the breakaway.

#### To automatically enable the resetting of the breakaway to the default breakaway after a switch:

1. Open the RCP-QE Panel Configuration editor (see “**Opening the RCP-QE Panel Configuration Editor**” on page 4–4).
2. Select the **Configuration** tab.
3. In the **Configuration** section, select the **Breakaway Reset** check box.
4. Send the current configuration file to the device (see “**Sending a Configuration File to a Device**” on page 4–33).

## Setting Up Menus

Menus can be used to group together certain functionality within the RCP-QE. You can store up to 250 menu pages in the RCP-QE. You can also define the fallback mode. This is what happens after an activity has been performed in a particular menu. Each menu page provides a new set of 17 buttons that you can assign with new functions.

For example, if you set up a menu containing all the breakaways, another menu containing all the destinations, and another menu containing all the sources, you can set up the menus so that once you have selected a breakaway, the menu containing all the destinations is shown so that you can select a particular destination device. Following this, the menu containing all the sources is shown so that you can select a particular source device.

- ★ By default, the first menu is defined as **Menu 0**, not **Menu 1**.

**To set up a menu:**

1. Open the RCP-QE Panel Configuration editor (see “**Opening the RCP-QE Panel Configuration Editor**” on page 4–4).
2. Select the **Menu Details** tab.
3. In the **Number of menus** box, enter or select the number of menus to match the requirements of your routing switcher system.
4. Click **Update**.
5. In the **Menu Number 1** row:
  - a. Click inside the **Menu Name** column and enter a name for the menu. The name can be up to 8 characters. This menu (**Menu 0**) is by default the first menu.
  - b. Press **Enter**.
  - c. Click the **Fallback Mode** column and use the list to select a fallback mode. Use the information in **Table 4.2** as a guide.

**Table 4.2 Fallback Mode Options**

<b>Option</b>	<b>Function</b>
Fallback Off	After a button in the menu is pressed, the RCP-QE remains on the menu. If you select <b>Fallback Off</b> , the corresponding value in the <b>Fallback Menu</b> column is ignored. You must provide extra menu navigation buttons within the menu so that you can exit from the menu.
First Menu	After a button in the menu is pressed, the RCP-QE returns to the first menu ( <b>Menu 0</b> in the <b>Menu Name</b> column). If the button that is pressed is assigned as a menu link or a menu navigation button, then the RCP-QE goes to that menu.
Previous Menu	After a button in the menu is pressed, the RCP-QE returns to the menu that it was on prior to the current menu. If the button that is pressed is assigned as a menu link or a menu navigation button, then the RCP-QE goes to that menu.
Specified Menu	After a button in the menu is pressed, the RCP-QE returns to the menu specified in the <b>Fallback Menu</b> column. If the button that is pressed is assigned as a menu link or a menu navigation button, then the RCP-QE goes to that menu.

6. If you have selected **Specified Menu** as the fallback mode, enter the specific menu number in the **Fallback Menu** column.
7. Define the next menu in the **Menu Name** column below the menus that you have defined previously. Repeat steps 5 to 6 until you have defined all of the menus that you want to use.
8. Send the current configuration file to the device (see “**Sending a Configuration File to a Device**” on page 4–33).

## Setting Up Button Display Options on the RCP-QE

You can set up the display options for each type of button on the RCP-QE so that you can distinguish between what types of functions have been assigned and whether or not the button is active. When a button is active, it shows the color and inverse settings for the selected state. When a button is not active, it shows the color and inverse settings for the default state.

You can select any of the available colors to represent default and selected states. You can also choose whether or not the default or selected state uses inverse.



– Default (not selected), not inverted



– Selected, inverted



– Default (not selected), inverted



– Selected, not inverted

#### To set the display options for a key type:

★ As you make changes to the default and selected colors, the changes are shown immediately in the preview keys to the right of the **Display Options** section.

1. Open the RCP-QE Panel Configuration editor (see “**Opening the RCP-QE Panel Configuration Editor**” on page 4-4).
2. Select the **Display Options** tab.
3. In the **Display Options** section, use the **Mode** column to locate the function for which you want to configure the display options.
4. Click inside the **Default Color** table cell and use the list to select a default color for the button display of the function.

If you want the text on the button to appear in inverse, select the **Invert Default** check box.

5. Click inside the **Selected Color** table cell and use the list to select a color for the button display of the function when it is selected.

If you want the text on the button to appear in inverse, select the **Invert Selected** check box.

6. Send the current configuration file to the device (see “**Sending a Configuration File to a Device**” on page 4-33).

## Assigning Functions to Buttons on the RCP-QE

The RCP-QE is programmed in the factory with default button assignments (see “**Default Configuration**” on page 4-10). If this default button assignment is not suitable for your routing switcher system, you can easily customize and save the configuration using DashBoard.

The RCP-QE can be programmed with 250 menu pages. Each menu can hold a different set of button functions. **Table 4.3** lists the functions you can assign across any menu.

**Table 4.3 Functions that can be assigned to buttons on the RCP-QE**

Function	Description
Destination	<p>The item of destination equipment that receives the physical output from the routing switcher. The destination is selected by pressing the button, but the switch is not made until the required source button is pressed. For more information, see “<b>Assigning a Destination or Source Button</b>” on page 4–18.</p> <p>By default, buttons 1 to 6 on the RCP-QE are assigned as destinations.</p>
Source	<p>The item of source equipment that sends the physical input to the routing switcher. A switch occurs when a source button is pressed and the signal is routed to the currently selected destination. For more information, see “<b>Assigning a Destination or Source Button</b>” on page 4–18.</p> <p>The function of any source button on a menu is changed when a <b>TAKE</b> button is assigned to the menu (see the information below on Take in the Function Key details).</p> <p>By default, buttons 7 to 13 on the RCP-QE are assigned as sources.</p>
Crosspoint	<p>A breakaway, destination, and source assigned to one button. A switch is achieved by pressing the crosspoint button rather than pressing a breakaway button, a destination button, and then a source button. For more information, see “<b>Assigning a Crosspoint Button</b>” on page 4–18.</p> <p>The function of any crosspoint button on a menu is changed when a <b>TAKE</b> button is assigned to the menu (see the information below on Take in the Function Key details).</p>
Function Key	<p>A function key enables you to assign a specific task to a button on the panel. The following functions are available to be assigned as a function key:</p> <ul style="list-style-type: none"> <li>• <b>Take (TAKE)</b> — The trigger that ends a hold on a switch sequence. This enables you to press the required breakaway, destination, and then source button combination, or crosspoint button or macro button, but not activate the switch until <b>TAKE</b> is pressed. If you have a take button assigned on a menu, it affects the behavior of the menu. You must use it to activate any switch that is set up. If you do not have a take button assigned to the menu, then a switch is made as soon as the source/crosspoint/macro button is pressed.</li> <li>• <b>Protect (PROT)</b> — A single button that places a block on the current destination, preventing its use by other sources. The protect button may also be held down to lock the RCP-QE.</li> <li>• <b>Chop (CHOP)</b> — A single button that starts a slow or fast toggle between the two most recently selected sources for a given destination.</li> <li>• <b>Deassign (DE-ASN)</b> — The de-assign button has two-fold functionality: a single button that provides a convenient method for disconnecting machine control ports and, if using virtual routing, a single button that allows you to free up resources when they are no longer needed for a path.</li> <li>• <b>MC Key (MC KEY)</b> — A single button that provides a convenient method for toggling reciprocal switching on and off when machine control is used.</li> <li>• <b>Panel Lock (LOCK)</b> — A single button that provides a convenient method for locking the RCP-QE against accidental or unwanted changes. The panel lock function can also be set by selecting the <b>Panel Locked</b> check box on the <b>Configuration</b> tab of the Panel Configuration editor or holding down a Protect button.</li> <li>• <b>Breakaway Step (BRK STEP)</b> — A single button that selects the next breakaway in the <b>Breakaway</b> table on the <b>Configuration</b> tab (see “<b>Setting Up Breakaways</b>” on page 4–12). If you want to view the levels used in the current breakaway, hold the breakaway step button (see “<b>Viewing the Breakaways Assigned to an RCP-QE</b>” on page 5–2). The breakaway step button does not illuminate when the default breakaway is selected. For help reading the levels from the hexadecimal expression, see <b>Table 7.1</b>.</li> </ul>
Level	<p>A specific router level assigned to a button. Pressing a level button selects that router level. Multiple levels can be selected. If a switch is made while a level button is pressed, the switch is made on that router level only. For more information, see “<b>Assigning a Level Button</b>” on page 4–19.</p>

**Table 4.3 Functions that can be assigned to buttons on the RCP-QE (Continued)**

Function	Description
Breakaway	<p>A predefined group of router levels assigned to a button. You select a breakaway as part of making a switch. For more information see, “<b>Setting Up Breakaways</b>” on page 4–12 and “<b>Assigning a Breakaway Button</b>” on page 4–20.</p> <p>If a level button is assigned for one or all of the router levels in a breakaway, then the level buttons corresponding to the router levels in the breakaway are illuminated when the breakaway button is selected. The level buttons do not illuminate when the default breakaway is selected.</p> <p>The breakaway button displays a breakaway warning when a switch that causes a breakaway error is made, except for the default breakaway (Breakaway 1).</p> <p>If you change the level pattern in DashBoard, a breakaway button must be pressed on the panel for the new level assignment to take effect.</p> <p>If you want to view the levels used in the current breakaway, hold the breakaway button (see “<b>Viewing the Breakaways Assigned to an RCP-QE</b>” on page 5–2). For help reading the levels from the hexadecimal expression, see <b>Table 7.1</b>.</p>
Macro	<p>A sequence of events (e.g. switches) that are assigned to a button. For more information, see “<b>Assigning a Macro Button</b>” on page 4–21.</p>
Menu Link	<p>A link that accesses a predefined menu via a single button. For more information, see “<b>Setting Up Menus</b>” on page 4–13 and “<b>Assigning a Menu Link Button</b>” on page 4–25.</p>
Menu Navigate	<p>A specific menu destination assigned to a button. You can set the button to return to <b>Menu Number 1 (Home)</b>, the next or previously visited menu, or go up or down a menu as defined on the <b>Menu Details</b> tab in the Panel Configuration editor.</p> <p>If <b>XPoint Layer</b> is selected, you can cycle through the current breakaway, destination, and source on any visible crosspoint buttons by repeatedly pressing the navigation button. The navigation button shows the current layer.</p> <p>For more information, see “<b>Assigning Menu Navigation to a Button</b>” on page 4–25.</p>
Display	<p>A status report that is displayed on a button. For example, if you choose to display the current output, then this button shows the output label for the currently selected destination. For more information see “<b>Assigning a Display to a Button</b>” on page 4–26.</p>
Clear Key	<p>A label (UN-ASN) indicating that the button does not have any of the button functions assigned to it and therefore does nothing when pressed. Select it to clear a button of any function assignment. For more information, see “<b>Clearing a Function from a Button</b>” on page 4–27.</p>
Salvo	<p>A salvo is a predefined list of switch events and is executed when a salvo button is pressed. Note that salvos are only applicable if the RCP-QE is connected to an Ultrix router.</p>

## The Button Configuration Box

The available button functions are listed in the **Button** configuration box. Click a button on the simulated panel to open the **Button** configuration box. Selecting a function from the button list will display the configurable aspects of that particular function to the right of the list. The following universal fields are also available in the **Button** configuration box:

**Auto-Advance** — select this check box to automatically select the next button on the panel. This function advances across the panel from left to right, top to bottom.

**Maintain Selection** — select the this check box if the **Auto-Advance** check box is selected and you wish to remain on the selected button.

**Quick Find** — type a function into the box to rapidly access that function from the button list.

**For More Information on...**

- the available functions, refer to **Table 4.3**.

## Assigning a Destination or Source Button

Destination and source buttons map the physical connections on the routing switcher to the RCP-QE. You can provide labels for these physical connections using the **Input Assigns** and **Output Assigns** tabs in the Panel Configuration editor for the RCP-QE (see “**Assigning Physical Connections for Control by an RCP-QE**” on page 4–11).

### To assign a destination or source to a button:

1. Open the RCP-QE Panel Configuration editor (see “**Opening the RCP-QE Panel Configuration Editor**” on page 4–4).
2. On the simulated RCP-QE, click the button that you want to use for the destination or source.  
The **Button** configuration box opens.
3. In the **Button** list, select **Destination** or **Source**.
4. Perform one of the following:
  - For a **Destination** button, use the **Value** list to select the physical output that connects to the item of destination equipment.
  - For a **Source** button, use the **Value** list to select the physical input that connects to the item of source equipment.

The simulated RCP-QE in DashBoard shows the label for the specified output/input on the selected button. If you have assigned a name to this output/input using the **Output Assigns/Input Assigns** tab, this name appears on the button.

5. Close the **Button** configuration box.
  6. Send the current configuration file to the device (see “**Sending a Configuration File to a Device**” on page 4–33).
- ★ If you have virtual routing enabled in the RCP-QE, the I/O that you enter represents the virtual destination as set up in the NK-VRC Virtual Routing Core.

## Assigning a Crosspoint Button

When you make a switch, you need to select the level(s) that you are switching using a breakaway or level button, the destination, and then the source. This requires three button presses. To reduce this effort and the potential for error, common switch sequences may be set up in a crosspoint.

- ★ You should also assign a menu navigation button on the same menu as a crosspoint button. Set the menu navigation button to **XPoint Layer**. This button may be used to toggle through the breakaway, destination, and source information in the crosspoint.

### To assign a crosspoint to a button:

1. Open the RCP-QE editor (see “**Opening the RCP-QE Panel Configuration Editor**” on page 4–4).
2. On the simulated RCP-QE, click the button that you want to use for the crosspoint.  
The **Button** configuration box opens.
3. In the **Button** list, select **Crosspoint**.
4. In the **Output** list, select the physical output that connects to the item of destination equipment to which you want to switch.
5. In the **Input** list, select the physical input that connects to the item of source equipment that provides the required signal.
6. In the **Breakaway** list, select the breakaway level that you want to use for the switch.
7. Close the **Button** configuration box.

The simulated RCP-QE in DashBoard shows **X-PNT** on the selected button.

8. Send the current configuration file to the device (see “**Sending a Configuration File to a Device**” on page 4–33).

**For More Information on...**

- assigning a menu navigation button, refer to “**Assigning Menu Navigation to a Button**” on page 4–25.

## Assigning a Function Button

A function button enables you to assign a specific task to a button on the panel.

**To assign a function to a button:**

1. Open the RCP-QE Panel Configuration editor (see “**Opening the RCP-QE Panel Configuration Editor**” on page 4–4).
2. On the simulated RCP-QE, select the button that you want to use for the function.  
The **Button** configuration box opens.
3. In the **Button** list, select **Function Key**.
4. Use the **Value** list to select one of the following functions:
  - **Take** — the trigger that ends a hold on a switch sequence.
  - **Protect** — a single button that places a block on the current destination. It can also be used to lock the panel.
  - **Chop** — a single button that starts a slow or fast toggle between the two most recently selected sources for a given destination.
  - **Deassign** — a single button that has two-fold functionality: a single button that provides a convenient method for disconnecting machine control ports and, if using virtual routing, a single button that allows you to free up resources when they are no longer needed for a path.
  - **MC Key** — a single button that provides a method for enabling reciprocal switching when machine control is used.
  - **Panel Lock** — a single button that locks the panel from accidental or unwanted changes.
  - **Breakaway Step** — a single button that selects the next breakaway in the **Breakaway** table.
5. Close the **Button** configuration box.  
The simulated RCP-QE in DashBoard shows the type of shift and shift page on the selected button. For example, **SRC SH2**.
6. Send the current configuration file to the device (see “**Sending a Configuration File to a Device**” on page 4–33).

## Assigning a Level Button

A level button enables you to select one router level per button for a switch. While a breakaway is similar, breakaways can contain more than one router level.

- ★ Multiple level buttons can be assigned on a panel.

**To assign a level to a button:**

1. Open the RCP-QE Panel Configuration editor (see “**Opening the RCP-QE Panel Configuration Editor**” on page 4–4).
2. On the simulated RCP-QE, click the button that you want to use for the level.  
The **Button** configuration box opens.
3. In the **Button** list, select **Level**.
4. In the **Value** list, select the router level that you want to assign to this button.
5. Close the **Button** configuration box.

The simulated RCP-QE in DashBoard shows the selected level on the button. For example, **Level 2**.

6. Send the current configuration file to the device (see “**Sending a Configuration File to a Device**” on page 4–33).

## Assigning a Breakaway Button

When you make a switch, you need to select the level(s) that you are switching using a breakaway. The breakaways should be set up before they are assigned to a button (see “**Setting Up Breakaways**” on page 4–12).

### To assign a breakaway to a button:

1. Open the RCP-QE Panel Configuration editor (see “**Opening the RCP-QE Panel Configuration Editor**” on page 4–4).
2. On the simulated RCP-QE, click the button that you want to use for the breakaway.

The **Button** configuration box opens.

3. In the **Button** list, select **Breakaway**.
4. In the **Value** list, select the breakaway that you want to assign to this button.
5. Close the **Button** configuration box.

The simulated RCP-QE in DashBoard shows the name of the breakaway on the selected button. For example, **Tied**.

6. Send the current configuration file to the device (see “**Sending a Configuration File to a Device**” on page 4–33).

★ If you change the level pattern in DashBoard, a breakaway button must be pressed on the panel for the new level assignment to take effect.

## Assigning a Breakaway Step Button

An RCP-QE may have several breakaways defined. If you want to cycle through the breakaways that have a non-zero level mask, a breakaway step button needs to be assigned to the RCP-QE. The button for the breakaway illuminates as it is selected. If you hold the breakaway step button for each breakaway, the levels defined in that breakaway are represented by eight hexadecimal characters on the screen. For help with reading the levels from the hexadecimal characters see **Table 7.1**.

### To assign a breakaway step button:

1. Open the RCP-QE Panel Configuration editor (see “**Opening the RCP-QE Panel Configuration Editor**” on page 4–4).
2. On the simulated RCP-QE, click the button that you want to use for the breakaway step.

The **Button** configuration box opens.

3. In the **Button** list, select **Function Key**.
4. In the **Value** field, select **Breakaway Step** as the function to assign to this button.
5. Close the **Button** configuration box.

The simulated RCP-QE in DashBoard shows the name of the breakaway step (**BRK STEP**) on the selected button.

6. Send the current configuration file to the device (see “**Sending a Configuration File to a Device**” on page 4–33).

★ When the configuration is sent to an RCP-QE, the button shows the name of the currently selected breakaway with the breakaway step indicator.



## Assigning a Macro Button

If you want to perform several tasks with the press of a single button, assign a macro button to the RCP-QE and then record a macro using this button. For information on recording a macro, see “**Recording a Macro Using the Panel**” on page 4–21. You can assign up to 40 macros to an RCP-QE.

### To assign a macro to a button:

1. Open the RCP-QE Panel Configuration editor (see “**Opening the RCP-QE Panel Configuration Editor**” on page 4–4).
2. On the simulated RCP-QE, click the button that you want to use for the macro.  
The **Button** configuration box opens.
3. In the **Button** list, select **Macro**.
4. In the **Value** list, select the macro number that you want to assign to this button.
5. Close the **Button** configuration box.  
The simulated RCP-QE in DashBoard shows the name of the macro on the selected button. For example, **Macro 1**.
6. Send the current configuration file to the device (see “**Sending a Configuration File to a Device**” on page 4–33).

## Recording a Macro Using the Panel

Macros can be recorded using the buttons on the RCP-QE. You may record up to 112 button presses in a macro. A macro button must be assigned on the RCP-QE before you can use it to record the macro. For more information on assigning a macro, see “**Assigning a Macro Button**” on page 4–21.

### To record a macro using the panel:

1. On the RCP-QE, hold the **Macro #x** button until the button shows **Macro Rec**.
  2. Release the button.  
The button flashes slowly, indicating that the RCP-QE is now ready to record a macro.
  3. Press the required buttons for the macro in the correct sequence until your task is completed.  
Each button acknowledges that it has been pressed by flashing briefly.
  4. Press the **Macro #x** button again to end the recording process.  
The macro is recorded.
- ★ If you unassign the **Macro #x** button from the macro function, the recorded macro is held in memory. You can reassign the macro to a button using the same macro number under which the macro was recorded.

## Adding to a Macro Using the Panel

You can add extra button sequences to an existing macro or you can join two existing macros together.

### To add to a macro using the panel:

1. On the RCP-QE, hold the **Macro #x** button until the button begins to flash rapidly.
2. Release the button.  
The button flashes slowly, indicating that the RCP-QE is now ready to record a macro.
3. Hold the **Macro #x** button again.  
The selected macro is played back internally and is then ready to receive the additional button sequences.

4. Do one of the following:
  - To add an extra button sequence, press the required buttons to add to the macro in the correct sequence until your task is completed.
  - To add an existing macro, press the button for the macro you want to add.

Each button acknowledges that it has been pressed by flashing briefly.

5. Press the **Macro #x** button again to end the recording process.

The existing macro is overwritten with the new macro.

## Configuring a Macro Using DashBoard

Macros can be configured in DashBoard using the **Macro Events** tab.

### To configure a macro using DashBoard:

1. Assign a macro to a button (see “**Assigning a Macro Button**” on page 4–21).
2. In **DashBoard**, open the RCP-QE Panel Configuration editor (see “**Opening the RCP-QE Panel Configuration Editor**” on page 4–4).
3. Select the **Macro Events** tab.
4. In the **Num. Rows.** box of the macro you want to configure, enter or select the number of events to be assigned.
5. Click **Update** to add the events to the **Event** column of the macro.
6. In the **Function** column, use the list to select the function to perform for the event. The options are as follows:
  - **Switch** — performs a standard crosspoint switch.
  - **Macro** — performs a macro within the executed macro.  
The Output column is the macro number and the other columns have no effect.
  - **Protect** — creates a protect condition on the destination of the selected crosspoint (see “**Assigning a Protect Button**” on page 4–23).  
The Output column is the output number, the Input column is the protect status (0 = release the protect for the output, 1 = take protect for this output), and the Level column has no effect.
- ★ Protect within a macro operates differently than that of a RCP-NKQ controller. The RCP-QE will assert a protect regardless of the current protect status. The RCP-NKQ would toggle the current protect status.
7. In the **Output** column, perform the following:
  - a. Click inside the **Output** table cell.
  - b. Enter a destination output number for the event.
8. In the **Input** column, perform the following:
  - a. Click inside the **Input** table cell.
  - b. Enter a source input number for the event.
9. In the **Level Mask** column, select the level mask(s) for the device affected by the macro. A selected router level is indicated by a blue square.  
Each function can occur on any available level, independent of any other function within the same macro event.
10. Repeat Steps 6 to 9 for any remaining events of the macro.
11. Send the current configuration file to the device (see “**Sending a Configuration File to a Device**” on page 4–33).

## Assigning a Name to a Macro Using DashBoard

Macros can be assigned custom names in DashBoard using the **Macro Names** tab.

### To assign a name to a macro using DashBoard:

1. In **DashBoard**, select the **Macro Names** tab.
2. In the **Name** column, perform the following:
  - a. Click inside the **Name** table cell of the macro.
  - b. Enter a name.
  - c. Press **Enter**.

The macro name is added to the button.

## Assigning a Protect Button

To prevent switching of critical crosspoints by others, assign a protect button for use on the RCP-QE. The protect function ensures that the selected destination can only receive the selected source across the selected levels. Once protected, the selected levels on a destination cannot be switched by other remote control panels (or by the same remote control panel if **Block All Panels** is selected). The source is not protected and can be freely routed to other destinations if required. You can protect any number of destinations. For more information see “**Protecting a Destination**” on page 5–5.

You can also use the protect button to lock the RCP-QE against all button presses (see “**Locking the RCP-QE**” on page 5–5).

### To assign a protect button using DashBoard:

1. Open the RCP-QE Panel Configuration editor (see “**Opening the RCP-QE Panel Configuration Editor**” on page 4–4).
2. On the simulated RCP-QE, click the button that you want to use for the level.  
The **Button** configuration box opens.
3. In the **Button** list, select **Function Key**.
4. In the **Value** list, select **Protect** as the function to assign to this button.
5. Close the **Button** configuration box.  
The simulated RCP-QE in DashBoard shows the protect (**PROT**) on the button.
6. Select the **Configuration** tab.
7. In the **Configuration** section, select the mode of protection that you want to use for the protect button. Use the information in **Table 4.4** as a guide:

**Table 4.4 Protect Mode Descriptions**

Protect Mode	Description
Block Other Panels	The protected destination and level(s) <i>cannot</i> be switched to another source by other remote control panels. The protected destination and level(s) <i>can</i> be switched to another source on the current remote control panel.
Block All Panels	The protected destination and level(s) <i>cannot</i> be switched to another source by the current remote control panel or other remote control panels.

8. Send the current configuration file to the device (see “**Sending a Configuration File to a Device**” on page 4–33).

## Assigning a Take Button

If you want to pre-load a switch sequence but delay the switch, assign a take button on the menu. If a take button is assigned, then all switches on that menu are activated by pressing the **TAKE** button instead of the source/crosspoint/macro button. You should assign a take button on each menu that requires this switching type.

### To assign a take button:

1. Open the RCP-QE Panel Configuration editor (see “**Opening the RCP-QE Panel Configuration Editor**” on page 4–4).
2. On the simulated RCP-QE, select the button that you want to use for the take button.  
The **Button** configuration box opens.
3. In the **Button** list, select **Function Key**.
4. In the **Value** field, select **Take** as the function to assign to this button.
5. Close the **Button** configuration box.

The simulated RCP-QE in DashBoard shows the take on the selected button.

6. Send the current configuration file to the device (see “**Sending a Configuration File to a Device**” on page 4–33).

★ If a take button is assigned, the selected source/crosspoint/macro button and the take button flash to indicate that the remote control panel is waiting for **TAKE** to be pressed.

## Assigning a Chop Button

If you want to toggle two different sources to the same destination, assign a chop button to the RCP-QE. For example, the destination may be the monitor that you are viewing, and the sources may be feeds from two different camera locations. When you use the chop button, the toggle rate can be slow or fast (see “**Toggling Between Two Sources**” on page 5–6).

### To assign a chop button:

1. Open the RCP-QE Panel Configuration editor (see “**Opening the RCP-QE Panel Configuration Editor**” on page 4–4).
2. On the simulated RCP-QE, select the button that you want to use for the chop button.  
The **Button** configuration box opens.
3. In the **Button** list, select **Function Key**.
4. In the **Value** field, select **Chop** as the function to assign to this button.
5. Close the **Button** configuration box.

The simulated RCP-QE in DashBoard shows the chop on the selected button.

6. Send the current configuration file to the device (see “**Sending a Configuration File to a Device**” on page 4–33).

## Assigning a Panel Lock Button

It may be necessary at times to lock the RCP-QE from access to the front panel. If this function is required, assign a panel lock button. You can also lock the RCP-QE using the **Panel Locked** check box on the **Configuration** tab (see “**Locking an RCP-QE**” on page 4–27). When a panel lock is applied, changes to the RCP-QE can still be made through the Panel Configuration editor in DashBoard.

### To assign a panel lock button:

1. Open the RCP-QE Panel Configuration editor (see “**Opening the RCP-QE Panel Configuration Editor**” on page 4–4).
2. On the simulated RCP-QE, select the button that you want to use for the panel lock.  
The **Button** configuration box opens.
3. In the **Button** list, select **Function Key**.
4. In the **Value** field, select **Panel Lock** as the function to assign to this button.
5. Close the **Button** configuration box.  
The simulated RCP-QE in DashBoard shows the lock on the selected button.

## Assigning a Menu Link Button

You can assign a predefined menu to a button on the RCP-QE. For information on how to set up a menu see “**Setting Up Menus**” on page 4–13.

### To assign a menu to a button:

1. Open the RCP-QE Panel Configuration editor (see “**Opening the RCP-QE Panel Configuration Editor**” on page 4–4).
2. On the simulated RCP-QE, select the button that you want to use for the menu link.  
The **Button** configuration box opens.
3. In the **Button** list, select **Menu Link**.
4. In the **Value** field, use the list to select the menu you want to assign to the button.
5. Close the **Button** configuration box.  
The simulated RCP-QE in DashBoard shows the menu on the selected button. For example, **Menu 3**.
6. Click the **Menu** list below the simulated RCP-QE and select the menu that you have just assigned.
7. Assign functions to the buttons in this menu (see “**Assigning Functions to Buttons on the RCP-QE**” on page 4–15).  
For example, if this menu is for the purpose of selecting a destination, assign the buttons as destinations. You may choose to have this destination menu fall back to a source menu.
8. Send the current configuration file to the device (see “**Sending a Configuration File to a Device**” on page 4–33).

## Assigning Menu Navigation to a Button

If you have multiple menus assigned in the RCP-QE, you may want to include some navigation buttons to enhance movement through the menus.

### To assign menu navigation to a button:

1. Open the RCP-QE Panel Configuration editor (see “**Opening the RCP-QE Panel Configuration Editor**” on page 4–4).
2. On the simulated RCP-QE, select the button that you want to use for menu navigation.  
The **Button** configuration box opens.
3. In the **Button** list, select **Menu Navigate**.
4. Use the **Value** list to select one of the following options:
  - **Home** — returns to the menu defined in **Menu Number 1** on the **Menu Details** tab.
  - **Next Menu** — goes to the next menu if one is held in the buffer.

- **Previous Menu** — goes to the previously used menu if one is held in the buffer.
  - **Up Menu** — goes up a menu as defined on the **Menu Details** tab.
  - **Down Menu** — goes down a menu as defined on the **Menu Details**.
  - **XPoint Layer** — shows the breakaway, destination, or source for any visible crosspoint buttons. You can step through the layers of a crosspoint by pressing the crosspoint layer button.
5. Close the **Button** configuration box.  
The simulated RCP-QE in DashBoard shows the type of navigation on the selected button. For example, **UP MENU**.
  6. Send the current configuration file to the device (see “**Sending a Configuration File to a Device**” on page 4–33).

## Assigning a Display to a Button

Assign the display function to a button if you want to view the status of the currently selected input, output, or breakaway. This button will show the name of the currently selected input, output, or breakaway.

### To assign a display to a button:

1. Open the RCP-QE Panel Configuration editor (see “**Opening the RCP-QE Panel Configuration Editor**” on page 4–4).
  2. On the simulated RCP-QE, select the button that you want to use for the display.  
The **Button** configuration box opens.
  3. In the **Button** list, select **Display**.
  4. Use the **Value** list to select one of the following options:
    - **Current Output** — the button displays the currently selected output.
    - **Current Input** — the button displays the currently selected input.
    - **Current Breakaway** — the button displays the currently selected breakaway. If a level button is selected on the RCP-QE, the level mask is shown as eight hexadecimal characters on the face of the display layer button.  
For help reading the levels from the hexadecimal expression, see **Table 7.1**.
 The simulated RCP-QE in DashBoard shows the type of display on the selected button, for example, **DISP INPUT**.
  5. Send the current configuration file to the device (see “**Sending a Configuration File to a Device**” on page 4–33).
- ★ When this configuration is sent to an RCP-QE, the button shows the label for the current source, destination, or breakaway (if the breakaway step button is used to cycle through the breakaways), for example **Server 1**, **Server 2**, or **SDI**.

## Assigning a Salvo to a Button

- ★ This function is only available when connected to an Ultrix router or Ultricore Central Controller.

A salvo is a predefined list of switch events. Salvos are stored within a central controlling device such as an Ultrix router or Ultricore Central Controller and may be accessed by any Remote Control Panel within the system. Salvo names are handled by the central controlling device and update the RCP-QE salvo names list automatically.

### To assign a salvo to a button:

1. Open the RCP-QE Panel Configuration editor as outlined in the section “**Opening the RCP-QE Connection Editor**” on page 4–2.
2. On the simulated RCP-QE, select the button that you want to use for the display.

The Button configuration box opens.

3. In the **Button** list, select **Salvo**.
4. Use the **Value** list to select one of the Salvo names.
5. Send the current configuration file to the device as outlined in the section “**Sending a Configuration File to a Device**” on page 4–33.

## Assigning a Category Index Mode Button

★ This function is only available when connected to an Ultrix series router or Ultricore Central Controller.

Category Index mode allows the grouping of sources and destinations in a hierarchical tree structure similar to the 'breadcrumb' user interface pattern found on many websites. Category Index also allows for numerical label extension selection for multiple labels having the same prefix. The assignment of sources and destinations is defined within a central controlling device (Ultrix router or Ultricore Central Controller).

**To assign a Category Index mode button:**

1. Open the RCP-QE Panel Configuration editor as outlined in the section “**Opening the RCP-QE Connection Editor**” on page 4–2.
2. On the simulated RCP-QE, select the button that you want to use for the display.

The Button configuration box opens.

3. In the **Button** list, select **Category Mode**.
4. Send the current configuration file to the device as outlined in the section “**Sending a Configuration File to a Device**” on page 4–33.

## Clearing a Function from a Button

If a button is not used for any function it should be unassigned.

**To clear a function from a button:**

1. Open the RCP-QE Panel Configuration editor (see “**Opening the RCP-QE Panel Configuration Editor**” on page 4–4).
2. On the simulated RCP-QE, select the button from which you want to clear a function.

The **Button** configuration box opens.

3. In the **Button** list, select **Clear Key**.
4. Close the **Button** configuration box.

The simulated RCP-QE in DashBoard blackens the selected button.

5. Send the current configuration file to the device (see “**Sending a Configuration File to a Device**” on page 4–33).

## Locking an RCP-QE

You can use DashBoard to lock access to the front of a remote control panel. The remote control panel can only be unlocked locally if you have assigned a panel lock or protect button. If these buttons have not been assigned, then the remote control panel may only be unlocked via DashBoard.

**To lock the RCP-QE:**

1. Open the RCP-QE Panel Configuration editor (see “**Opening the RCP-QE Panel Configuration Editor**” on page 4–4).
2. Select the **Configuration** tab.

3. In the **Configuration** section, select the **Panel Locked** check box.
4. Send the current configuration file to the device (see “**Sending a Configuration File to a Device**” on page 4–33).

The RCP-QE is locked.

- ★ If a panel lock button is assigned, it can be pressed to unlock the RCP-QE.

If a protect button is assigned, it can be held to unlock the RCP-QE.

If neither of these buttons are assigned, the RCP-QE can only be unlocked by clearing the **Panel Locked** check box in DashBoard and then sending the configuration file to the device.

## Setting Up Machine Control

If your routing switcher system uses a machine control routing switcher to provide reciprocal switching of RS-422 signals, your RCP-QE must be set up to handle these switches. Machine control must be enabled in the RCP-QE and the router level used for machine control must match that set in the machine control routing switcher.

### To set up machine control:

1. Open the RCP-QE Panel Configuration editor (see “**Opening the RCP-QE Panel Configuration Editor**” on page 4–4).
2. Select the **Configuration** tab.
3. In the **Configuration** section, select the **Machine Control Enabled** check box.
4. Use the **Machine Control Level** box to enter or select the machine control level to match the level that the machine control routing switcher has been assigned.
5. Send the current configuration file to the device (see “**Sending a Configuration File to a Device**” on page 4–33).

## Assigning a Machine Control Button

If your master device controls multiple slave devices, you need a machine control button to temporarily disable reciprocal switching until the last slave device is routed.

### To assign a machine control button:

1. Open the RCP-QE Panel Configuration editor (see “**Opening the RCP-QE Panel Configuration Editor**” on page 4–4).
2. On the simulated RCP-QE, select the button that you want to use for machine control.

The **Button** configuration box opens.

3. In the **Button** list, select **Function Key**.
4. Use the **Value** list to select **MC Key**.
5. Close the **Button** configuration box.

The simulated RCP-QE in DashBoard shows **MC KEY** on the selected button.

6. Send the current configuration file to the device (see “**Sending a Configuration File to a Device**” on page 4–33).

## Assigning a De-assign Button

De-assign will disconnect a reciprocal machine control path through a machine control router, parking sources to their respective destinations. Similarly, if using resource management, de-assigning will park the resource inputs and outputs and de-allocate the resource to be used in other routes.



**For More Information on...**

- resource management, refer to “**Setting Up Virtual Routing and Resource Management**” on page 4–30.

**To assign a de-assign button:**

1. Open the RCP-QE Panel Configuration editor (see “**Opening the RCP-QE Panel Configuration Editor**” on page 4–4).
2. On the simulated RCP-QE, select the button from which to de-assign a machine control port.  
The **Button** configuration box opens.
3. In the **Button** list, select **Function Key**.
4. Use the **Value** list to select **Deassign**.
5. Close the **Button** configuration box.  
The simulated RCP-QE in DashBoard shows **DE-ASIGN** on the selected button.
6. Send the current configuration file to the device (see “**Sending a Configuration File to a Device**” on page 4–33).

## Linking Remote Control Panels

If your routing switcher system is extensive, control of the entire system may not be possible through just one remote control panel. If this is the case, additional remote control panels may be added, as described on “**Installing the RCP-QE**” on page 3–1. You can choose to operate the remote control panels individually, or you can link the remote control panels together so they operate as one larger remote control panel.

- ★ When multiple remote control panels are linked, the Address field must be the same for all linked remote control panels, and the Panel Link Address field must be different for each remote control panel.

**For More Information on...**

- operating linked remote control panels, refer to the section “**Operating Linked Remote Control Panels**” on page 5–8.

You may link RCP-ME, and RCP-QE, RCP-NKM, and RCP-NKQ remote control panels together. You cannot link the RCP-NK1 with an RCP-ME, or RCP-QE, RCP-NKM, or RCP-NKQ. You may link up to 10 remote control panels together.

- ★ RCP-QE panel linking requires a connection to either an NK-NET, an Ultrix router, or an Ultrix Central Controller. The NK-IPS does not support panel linking.

The **Panel Address** and **Panel Link Address** must be different within each remote control panel. For example, if you have three RCP-QE panels but only want to link two panels, you would assign the Panel Address and Panel Link Addresses as outlined in **Table 4.5**. In this example, the first and second panels are linked to form one logical remote control panel.

**Table 4.5 Example of Linked Panel Addresses**

	First RCP-QE	Second RCP-QE	Third RCP-QE
Setup	Linked		Unlinked
Address	100	100	120
Panel Link Address	1	2	0

**To link remote control panels together:**

1. Launch the RCP-QE editor as outlined in the section “**Opening the RCP-QE Connection Editor**” on page 4–2.
2. In the **Address** field of the **Device Details** area, enter the common address (between 2 and 255) that you want all the linked remote control panels to use.

3. Select the **Configuration** tab.
4. In the **Panel Link Address** field of the **Panel Link** area, enter the individual address (between 1 and 254) that you want this particular remote control panel to use. By default, the panel link address of a remote control panel is set to zero (0).
- ★ If a panel has a **Panel Link Address** of **0**, it cannot have the same address of another panel or other NK series device. If it does, the results will be unpredictable.
5. Send the current document to the device as outlined in the section “**Sending a Configuration File to a Device**” on page 4–33.
6. Repeat this process for all of the remote control panels that you want to link together.

## Setting Up Virtual Routing and Resource Management

So far, the routing systems described in this user guide use physical switching only. That is, source 1 on level 1 refers to the first input on the back of a routing switcher assigned to level 1. When an NK-VRC Virtual Routing Core is added to the system, virtual routing is possible. With virtual routing, physical inputs and outputs are mapped to virtual sources and destinations. For example, a virtual source may switch input 15 on level 1 and input 27 on level 2.

The RCP-QE must have virtual routing enabled to use this feature. When virtual routing is enabled, the sources and destinations that you assign on the RCP-QE refer to the virtual sources and destinations as defined in the NK-VRC.

- ★ The Ultracore control system on which Ultrix and Ultracore Central Controller operate, is a logical control system. If the RCP-QE is connected to an Ultrix router or Ultracore Central Controller, virtual routing (also known as logical routing) must be enabled.

Additionally, resource management may be implemented on the NK-VRC to manage routing of different signal types between one or more routers using external resources. If using resource management, assigning a de-assign to a button will allow the user to park the resource inputs and outputs and de-allocate the resource to be used in other routes.

### For More Information on...

- setting up and using an NK-VRC see the *NK-VRC Virtual Routing Core User Guide*.

### To set up virtual routing and resource management:

1. Open the RCP-QE Panel Configuration editor (see “**Opening the RCP-QE Panel Configuration Editor**” on page 4–4).
2. Select the **Configuration** tab.
3. In the **Configuration** section, select the **Virtual Routing Enabled** check box.
4. Send the current configuration file to the device (see “**Sending a Configuration File to a Device**” on page 4–33).

### To assign a de-assign a button:

1. Open the RCP-QE Panel Configuration editor (see “**Opening the RCP-QE Panel Configuration Editor**” on page 4–4).
2. On the simulated RCP-QE, select the button from which to de-assign a resource.  
The **Button** configuration box opens.
3. In the **Button** list, select **Function Key**.
4. Use the **Value** list to select **Deassign**.
5. Close the **Button** configuration box.

The simulated RCP-QE in DashBoard shows **DE-ASIGN** on the selected button.

6. Send the current configuration file to the device (see “**Sending a Configuration File to a Device**” on page 4–33).

## Setting the Retry Time for a Switch Failure

When you make a switch, a switch request is sent from the RCP-QE to the NK-NET (or NK-IPS) and forwarded to the NK routing switcher. If the RCP-QE does not receive a response from the routing switcher, the RCP-QE retries the request after the time specified in the **Comms Retry Delay Factor** field.

Systems require different retry times depending on the transfer of requests and responses between modules.

**Table 4.6 Example Retry Times**

System	Retry Time (ms)
Dedicated local network (direct connection to router specified via an NK-NET or NK-IPS)	20
Dedicated local network with one of the following: NK-VRC Virtual Routing Core, Ultrix router, or Ultricore Central Controller	50 or greater
Shared local network (non-dedicated general facility)	100
Remote or VPN connection	250

- ★ If switch performance appears slow and the log shows multiple retry and timeout events, you should increase the retry time.

### To set the retry time:

1. Open the RCP-QE Panel Configuration editor (see “**Opening the RCP-QE Panel Configuration Editor**” on page 4–4).
2. Select the **Configuration** tab.
3. In the **Configuration** section, use the **Comms Retry Delay Factor** box to adjust the retry time (in milliseconds) according to the requirements of your routing switcher system (see **Table 4.6**).
4. Send the current configuration file to the device (see “**Sending a Configuration File to a Device**” on page 4–33).

## Returning to the Home Menu

You can use DashBoard to return to the Home menu if the RCP-QE is not responding to button presses.

### To return to the home menu:

1. Open the RCP-QE Panel Configuration editor for the RCP-QE that is not responding (see “**Opening the RCP-QE Panel Configuration Editor**” on page 4–4).
2. Select the **Configuration** tab.
3. In the **Configuration** section, select the **Return to Home Menu** check box.
4. Send the current configuration file to the device (see “**Sending a Configuration File to a Device**” on page 4–33).

The RCP-QE returns to the **Home** menu.

## Loading Factory Defaults Using DashBoard

If you need to return the RCP-QE to a known configuration, you can use DashBoard to load the factory defaults.

### To load the factory defaults:

1. Open the RCP-QE Panel Configuration editor for the RCP-QE (see “**Opening the RCP-QE Panel Configuration Editor**” on page 4–4).
2. Select the **Configuration** tab.
3. In the **Configuration** section, select the **Load Factory Defaults** check box.
4. Send the current configuration file to the device (see “**Sending a Configuration File to a Device**” on page 4–33). Ensure that only the **Home** page is selected in the **Send Config to NK Device** dialog box. De-select all other pages or they will be sent to the device as well, thus changing the factory defaults.

The factory defaults are loaded.


- ★ This defaults the RCP-QE panel configuration (Panel Configuration editor) only, and not the connection configuration (Connection Editor).

## Saving the Current Configuration for the RCP-QE

The parameters that you have set up on the Panel Configuration editor tab for an RCP-QE are stored in a configuration file. When you have finished making changes to the configuration of the RCP-QE, you should save the configuration file and then add the location of this file to the **File Navigator** pane so that you can open it later.


### Saving a New Configuration File

#### To save a new configuration file:

1. Select the Panel Configuration editor tab containing the configuration that you want to save.
2. Click **Save As** (  ) to save the current configuration.  
The default location is Desktop\Documents.
3. Navigate to the folder in which you want to save the configuration file.
4. Click **Save**.

### Adding a Directory to File Navigator


#### To add the configuration file location to the File Navigator pane:

1. In the **File Navigator** pane, click **Add a directory** (  ).  
The **Browse For Folder** window opens.
2. Navigate to the folder where you saved the configuration file.
3. Select the folder.
4. Click **OK**.

The folder and any saved configuration files can now be accessed via the **File Navigator** pane.

### Saving an Existing Configuration

#### To save an existing configuration:

1. Select the Panel Configuration editor tab containing the configuration that you want to save.
2. In the **File Navigator** pane, select the configuration file to which you want to save the current configuration.
3. Click  to save the current configuration.

## Opening a Saved Configuration

### To open a saved configuration:

1. In the **File Navigator** pane, navigate to the saved configuration file that you want to open.
2. Double-click on the icon for the file.

## Sending a Configuration File to a Device

When you have made changes to the configuration of a device, the changes are not activated in the device until the changes to the configuration are sent to the device. You can open a saved configuration file, make changes to it, save it, and then send it to a device.

### To send the current configuration to a device:

1. Select the Panel Configuration editor tab containing the configuration that you want to send to a device.  
If you want to send the default configuration to a device, open the default configuration file from the **File Navigator** pane (see “**Opening a Saved Configuration**” on page 4–33).
2. In the **Basic Tree View** pane, select the corresponding device.
3. Click **Send Configuration**.

The **Send Config to NK Device** dialog box opens. Any of the pages containing information that has been changed are automatically selected for sending to the device.



**Figure 4.6** Send Config to NK Device dialog box

4. Select the pages that you want to send to the device. Use the information **Table 4.7** as a guide.

**Table 4.7** Page Descriptions

Page	Description
Select Pages	Selecting this selects every page to send to the device.
Home	The information contained in the <b>Device Details</b> frame and the <b>Configuration</b> tab.
Key Definitions	The information defining how buttons have been assigned.
Menu Details	The information contained on the <b>Menu Details</b> tab.
Labels	The information contained in the combined pool of input and output labels.
Input Assign	The information contained on the <b>Input Assigns</b> tab.
Output Assign	The information contained on the <b>Output Assigns</b> tab.
Macro Names	The information contained on the <b>Macro Names</b> tab.
Macro Events	The information contained on the <b>Macro Events</b> tab.

5. In the **Select Devices** list, select the device to which you want to send the current configuration.
6. Click **Send**.
7. In the **Basic Tree View** pane, right-click on the device and select **Reload**.  
The device is reloaded with the new configuration.

# Operating the RCP-QE

## LCD Buttons

The LCD buttons reflect any one of the following, depending on their current use:

- current status
- label
- current display mode
- special indicators

The text on the button changes as required. The color and inverse settings change depending upon the status of the button and how these display options have been set up. The default status shows when the button is not selected. The selected status shows when the button is selected.

The special indicators for the LCD buttons are as follows:



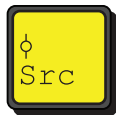
– Breakaway warning indicator (breakaway and source buttons)



– Breakaway step indicator (breakaway step button)



– Crosspoint indicator (crosspoint button)



– Crosspoint layer indicator (crosspoint layer button)



– Protection indicator (destination and protect button)



– Navigation indicator (menu navigation button)

### For More Information on...

- the display options for the RCP-QE buttons, refer to “**Setting Up Button Display Options on the RCP-QE**” on page 4–14.

## Breakaways and Levels

Breakaways are made up of one or more levels that are defined as a level mask and then assigned to a button (see “**Setting Up Breakaways**” on page 4–12). You can assign multiple breakaway buttons to an RCP-QE. You can select only one breakaway for a switch.

One level may be assigned to a button. You can assign multiple level buttons to an RCP-QE. You can select multiple level buttons prior to a switch. If you change the level pattern in DashBoard, a breakaway button must be pressed on the panel for the new level assignment to take effect.

## Selecting Breakaways and Levels

### To select a breakaway or level:

1. Press the corresponding button.

The button shows the color and inverse status for a selected breakaway or level. If you have selected a custom breakaway, and separate level buttons are assigned to the RCP-QE, the level keys corresponding to the levels in the breakaway also show the color and inverse status for a selected button.

When a breakaway is selected, the status of the routing switcher shown on the button is the status of the lowest router level in the breakaway.

If a breakaway warning is indicated on the button, it shows the routing switcher status in the current breakaway when compared to the router levels defined in the breakaway in the configuration.

- ★ You cannot add a level to a custom breakaway by pressing a level button.
- ★ A breakaway warning is caused by:
  - › No response from the routing switcher system on one or more router levels.
  - › A difference in status of any level in the currently selected breakaway when compared with the first level in the breakaway (or default breakaway if the **Breakaway Warning Mode** is set to default).

### To de-select a breakaway:

- Select another custom breakaway, the default breakaway, or a level button.

### To de-select a level:

- Press the level button again.

## Viewing the Breakaways Assigned to an RCP-QE

You can view the breakaways assigned to an RCP-QE if a breakaway step button is assigned to the RCP-QE. The breakaway step button cycles to the next breakaway in the list each time it is pressed and shows the name of the currently selected breakaway, with the breakaway step indicator in the bottom right of the button. As each breakaway is selected, the level(s) defined in that breakaway are illuminated if corresponding level buttons have been assigned to the RCP-QE.

### To view the breakaways assigned to an RCP-QE:

- Press the breakaway step button repeatedly to cycle through the available breakaways.

The breakaway step button shows the selected status as you cycle through the breakaways. When the default breakaway is selected, the breakaway step button changes to the default status.

- ★ If a breakaway warning exists, it is indicated at the bottom right of the breakaway button and the source button.

### To view the levels of a breakaway:

- Hold the breakaway button or the breakaway step button.

An 8-character expression appears on the button. Each character provides a hexadecimal representation of the use of four levels, from 32 to 29 on the left, through to 4 to 1 on the right. **Table 7.1** provides a look-up table for reading the levels from the hexadecimal characters.

- ★ If level buttons have been assigned to the RCP-QE, these show the selected status. The level buttons show the default status when the default breakaway is selected.



## Making a Switch

A switch can be made with or without a take button assigned to the menu. If there is no take button assigned, a switch is made when the source/crosspoint/macro button is pressed. If a take button is assigned to the menu, the switch is made when the take button is pressed.

### Switching with a Breakaway, Destination, and Source

#### To make a switch:

1. Press the button(s) for the level(s) or breakaway that you want to use.

If you do not select a custom breakaway or level button, the default breakaway is used.

To de-select a level, press the button again.

2. Press the destination button that you want to use.

3. Press the source button that you want to use.

If a take button is assigned to the menu, the text on the screen that identifies the source button alternates between **Take ?** and the selected source label. The source button flashes with the **TAKE** button.

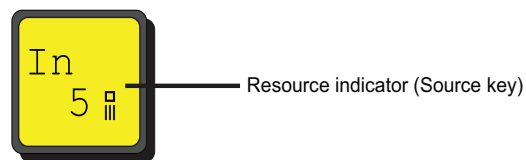
4. If a take button is assigned to the menu, press **TAKE**.

5. If you want to protect the destination, press the protect button (**PROT**) if it has been assigned (see “**Protecting a Destination**” on page 5–5).

- ★ If you have selected the **Breakaway Reset** check box, the breakaway returns to the default breakaway after the switch is made.

If resource management is used, the following may occur:

- › If the requested switch includes a resource, the button will display a resource indicator as shown in **Figure 5.1**.



**Figure 5.1** Resource indicator for the source button LCD

After pressing the source button to initiate a switch:

- › if no rule can be found to connect two classes, it displays a **NO RULE** message
- › if no resource exists for the selected rule, it displays a **NO RSRCE** message
- › if resource exists but panel priority does not have access rights, it displays a **NO ACCES** message

### Switching with a Crosspoint

#### To make a switch using a predefined crosspoint button:

1. Press the crosspoint button.

2. If a take button is assigned to the menu, press **TAKE**.

3. If you want to protect the switch, press **PROT Off** if it has been assigned (see “**Protecting a Destination**” on page 5–5).

- ★ When you make a crosspoint switch, the corresponding breakaway, destination, and source keys illuminate.

If you have selected the **Breakaway Reset** check box in the configuration document for the RCP-QE, the breakaway returns to the default breakaway after the switch is made.

## Using a Macro

You can use macros on the RCP-QE.

### To use a macro:

1. Create a macro (see “**Assigning a Macro Button**” on page 4–21).
2. Press the macro button.
3. If a **TAKE** button is assigned to the menu, press **TAKE**.

## Using a Salvo

★ This function is only available when connected to an Ultrix router or Ultricore Central Controller.

A salvo is a predefined list of switch events. Salvos are stored within a central controlling device such as an Ultrix router or Ultricore and may be accessed by any Remote Control Panel within the system. Salvo names are handled by the central controlling device and update the RCP-QE salvo names list automatically.

### To use a salvo:

1. Create a salvo as outlined in the Ultrix or Ultricore documentation.
2. Press the assigned **Salvo** macro button. This is the button you configured using the procedure “**To assign a salvo to a button:**” on page 4–26.
3. If a **TAKE** button is assigned to the menu, press **TAKE**.

## Using Category Index Mode

★ This function is only available when connected to an Ultrix router or Ultricore Central Controller.

Category Index is a mode of operation. Category Index mode allows the grouping of sources and destinations in a hierarchical tree structure similar to the 'breadcrumb' user interface pattern found on many websites. The traditional menu structured navigation pattern is available once the Category Index mode is exited or the user has made a selection. The assignment of sources and destinations is defined within a central controlling device such as the Ultrix router or Ultricore.

### To enter Category Index mode:

1. Press the **CAT MODE** button to enter Category Index mode. This is the button you configured using the procedure “**To assign a Category Index mode button:**” on page 4–27.

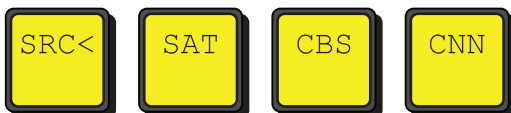


A **Category** menu opens.



2. Press Sources, Destinations, Levels or Salvos as required.

Sub-categories and selection keys (source /destination/level selection) are now available. Example data is shown below:



3. If assigned within the category structure, numerical extension for like label prefixes presents a numerical keypad for selection.



4. Pressing the Left most button with the back arrow, or the category name before the current category traverses back up the tree one step.

## Locking the RCP-QE

You can lock the RCP-QE if a panel lock or protect button has been assigned to the RCP-QE.

The protect button must be held to lock the RCP-QE.

### To lock the RCP-QE using a panel lock button:

1. Press **LOCK Off**.

The panel lock key flashes red three times before returning to the default status. The label changes to **LOCK On**.

Every key on the RCP-QE becomes inactive, except for the **LOCK On** key.

2. If you want to unlock the RCP-QE, press **LOCK On**.

The text on the panel lock key changes to **LOCK Off**.

### To lock the RCP-QE using a protect key:

1. Hold **PROT Off** for 3 seconds.

Every key on the RCP-QE becomes inactive except for the **PROT Off** key and **LOCK On** key, if assigned.

2. If you want to unlock the RCP-QE, hold **PROT Off** or press the panel lock key, if assigned.

★ If a panel lock key is assigned to the RCP-QE, this key changes to **LOCK On** and the **PROT Off** key remains the same.

## Protecting a Destination

You can use a protect button to prevent switching of critical crosspoints by others. The protect function ensures that the selected destination can only receive the selected source across the selected levels. Once protected, the selected levels on a destination cannot be switched by other remote control panels (or by the same remote control panel if **Block All Panels** is selected). The source is not protected and can be freely routed to other destinations if required. You can protect any number of destinations.

You can set the extent of protection that is used via DashBoard, such as protected against other remote control panels or protected against all remote control panels (see “**Assigning a Protect Button**” on page 4–23).

### To protect a destination:

1. Make the switch.
2. Press **PROT Off**.

The status of the protect key changes to **PROT Loc**, and the protection indicator is shown at the bottom right of both the protect key and the destination key.

★ If you are protecting a destination on a level for which a routing switcher does not respond, a protect breakaway error (**BwayErr**) occurs.

#### To remove the protection from a destination:

1. Press the button for the protected destination.
2. Press **PROT Loc**.

The status of the key changes to **PROT Off** and the protection indicator is removed from the destination key.

## Clearing Protects Held by an RCP-QE

A protect that is held by an RCP-QE prevents the crosspoint being changed by another user. A protect can be sent to the routing switcher from any connected remote control panel. Protects can be applied at any time and are indicated by the protection indicator at the bottom right of the destination key.

#### To clear one protect from an RCP-QE:

1. Press the destination button that has the protection applied.

The protection indicator is shown at the bottom right of the destination button.



*Figure 5.2 Protection Indicator for Destination Button*

2. Press **PROT Loc**.

#### To clear all of the protects from an RCP-QE:

1. Open the RCP-QE Panel Configuration editor (see “**Opening the RCP-QE Panel Configuration Editor**” on page 4–4).
2. Select the **Configuration** tab.
3. In the **Configuration** section, select the **Clear Protect(s)** check box.
4. Send the current configuration to the device (see “**Sending a Configuration File to a Device**” on page 4–33).

★ Protects may be held by other remote control panels. Each remote control panel attached to a routing switcher has to have its protects cleared separately.

## Toggling Between Two Sources

If a chop button has been assigned to the RCP-QE, you can use this button to toggle between two sources.

#### To toggle between two sources:

1. Press the button for the destination on which you want to receive the sources.
2. Press the button for the first source that you want to receive.
3. Press the **TAKE** button, if assigned.
4. Press the button for the second source that you want to receive.
5. Press the **TAKE** button, if assigned.
6. Do one of the following:
  - Press **CHOP** once to toggle slowly between the two sources (toggle cadence is 1700 ms). The status of the button changes to **CHOP Slow** and the two source buttons illuminate alternately.
  - Press **CHOP** twice to toggle rapidly between the two sources (toggle cadence is 400 ms). The status of the button changes to **CHOP Fast** and the two source buttons illuminate alternately.

7. Do one of the following:

- If you are in slow chop, press **CHOP** twice to stop toggling between the two sources.
- If you are in fast chop, press **CHOP** once to stop toggling between the two sources.

The status of the button returns to **CHOP**.

## Using a Menu

The button corresponding to the current menu is always illuminated.

### To use a menu:

1. Press the button that has the menu assigned to it.
2. Press the button that you want to use in that menu.

If the menu has been set up to fall back to another menu, the RCP-QE goes to the predefined menu (see “**Setting Up Menus**” on page 4–13).

★ If you need to return to the **Home** menu but the RCP-QE is not responding, use DashBoard to do this. For more information see “**Returning to the Home Menu**” on page 4–31.

## De-Assigning a Machine Control Port

If you want to stop machine control on a particular port temporarily, you can park the port by de-assigning it.

### To de-assign a machine control port:

1. Press the button for the machine control port that you want to park.
2. Press **DE-ASIGN**.

### To unpark the machine control port:

- Make a machine control switch.

## De-Assigning Resources

De-assigning resources can be done in two ways:

- Route a different source to that destination that does not require a resource. The assigned resource will automatically be de-assigned.
- Use the de-assign button.

### To-deassign a resource:

1. Select the destination to which the resource is attached.
2. Press **DE-ASIGN**.

If the selected destination does not include a resource, one of two things will occur:

- If the panel is in MC mode, park the current destination (switch same source number to destination).
- If the panel is not in MC mode, it displays the **MC MODE?** message.

★ The ability of a panel to de-assign a resource using the de-assign button will depend on the priority assigned to the panel and the resource in the NK-VRC virtual routing core.

## Resetting Devices

If you want to return to a known operating state and configuration, you can:

- send the default configuration to the RCP-QE (see “**Sending a Configuration File to a Device**” on page 4–33)
- reset the device
- reload the factory defaults

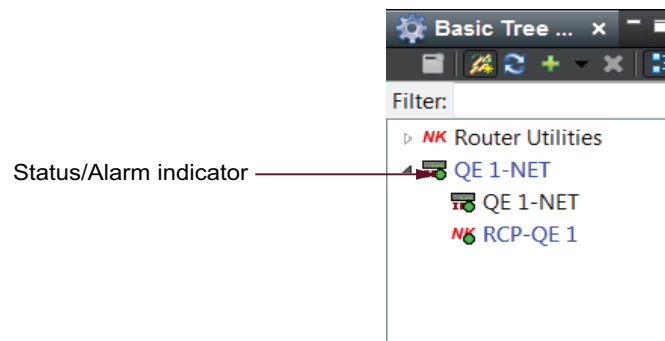
If the RCP-QE fails to accept any configuration files that are sent to it, then you should reset the device. When you perform a reset, the RCP-QE takes on the last-known operating state and configuration that is stored in memory. If the RCP-QE fails to reset, then reload the factory defaults.

### To reset a device:

1. Open the RCP-QE Panel Configuration editor (see “**Opening the RCP-QE Panel Configuration Editor**” on page 4–4).
2. Click **Reboot**.

## Viewing Status and Alarms

An indication that alarms are present for a device is visible in the **Basic Tree View** pane. If a device has one or more alarms, a small circle appears in the icon for the device.



*Figure 5.3 Basic Tree View pane showing device with status/alarm indication*

The status and alarms are also viewable in the Configuration tab of the Panel Configuration editor.

### To view the status and any alarms for an RCP-QE:

1. Open the RCP-QE Panel Configuration editor (see “**Opening the RCP-QE Panel Configuration Editor**” on page 4–4).
2. Select the **Configuration** tab.
3. View the status and alarms in the **Alarms** section.

The status of the RCP-QE is shown via a number of colored indicators:

- **Green** – device is connected and operational.
- **Yellow** – alarm is active. For example, a protect is active on the panel.
- **Red** – device has been rebooted. Refresh the **Basic Tree View** in Dashboard to clear this status.
- **Orange** – no active Dashboard connection. A forced connection is required.

## Operating Linked Remote Control Panels

You can link multiple RCP-QEs together, or link them with one or more RCP-ME, RCP-NKMs, or RCP-NKQs, or combination thereof. The remote control panels must have panel link addresses set, as described in the section “**Linking Remote Control Panels**” on page 4–29. Once these addresses are set correctly, the remote control panels

transfer status, request and response information between them. Effectively, the remote control panels combine to form one big remote control panel. Up to 255 remote control panels may be linked together.

For example, if you want to operate a 34-key remote control panel with the inputs and outputs of a  $32 \times 32$  routing switcher, you may link two RCP-QE panels together. Another use may be to define all the crosspoints that you need without using menus and pages. To do this, you need as many keys as there are crosspoints.

★ The input and output assign labels should be identical across all remote control panels.

## Function Buttons

Once remote control panels are linked, they operate in a manner similar manner as to their the unlinked state operation. If a special function button (CHOP, DE-ASSIGN, or a PANEL LOCK, PROTECT, Breakaway, Breakaway Step or machine control) is assigned to one remote control panel, it is effective across all linked remote control panels, regardless of the location of other relevant buttons.

- A TAKE button does not operate across menus within the same remote control panel however, it does operate across linked remote control panels as long as it is on a current menu at the time that the source/crosspoint/macro key is pressed. For example, a TAKE function will only operate on a currently visible menu on any of the linked remote control panels. If a TAKE button is not visible, then the TAKE function will not operate.
- If a TAKE button is assigned, the selected source/crosspoint/macro button and the TAKE button flash to indicate that the remote control panel is waiting for TAKE to be pressed.
- Only a single CHOP button is supported.
- Only a single button is supported for any given MACRO.
- A PROTECT will operate across linked panels to each linked panels current protect mode. For example, if a PROTECT is issued from a linked panel with a Protect mode of “block\_all”, but a linked panel has a Protect mode of “block\_others” then the two linked panels will interpret the PROTECT function differently. This may have unintended consequences. It is recommended that all panels in the linked panel setup are configured with the same Protect mode. Refer to the section “**Configuration**” on page 4–6 for more information on the Protect mode options.

## Destinations and Sources

Destinations and sources from different remote control panels may be selected. For example; a destination button is pressed on one linked panel, then a source selected on another linked panel will result in the router/s switching that source to that destination on the current breakaway.

## Crosspoints

A crosspoint button is a source, destination, and breakaway all in one button offering single button press router switching. Crosspoints can only be programmed to a remote control panel via Dashboard. Crosspoint buttons operate normally in linked panel mode.

## Switching

When a breakaway, destination and source are sent in a switch request from a remote control panel, each linked remote control panel receives the level mask (levels that make up the breakaway), destination and source information via a linked panel message, and either reflects the status, or behaves accordingly (for example, locking the remote control panel or entering macro record mode).

## Breakaways

Breakaway numbers are not sent in the switch request, thus removing the need for identical breakaway definitions across linked remote control panels. As such, breakaway step is not available across linked remote control panels.

You can view the breakaways within the same remote control panel, in line with unlinked behavior.

## Menus

Menus and menu navigation buttons are only effective on the remote control panel to which they are assigned.

## Macros

Macros may be recorded or added across linked remote control panels.



# Troubleshooting

**Table 6.1 Troubleshooting**

<b>Problem</b>	<b>Cause</b>	<b>Action</b>
I am stuck on a menu with no way back.	A return loop was not set up when the menu was defined.	Use DashBoard to return to the Home menu (see “ <b>Returning to the Home Menu</b> ” on page 4–31).
RCP-QE is not responding to DashBoard.	Information stored in the RCP-QE has been corrupted.	Try the following until the RCP-QE responds: <ul style="list-style-type: none"><li>• Reset the RCP-QE</li><li>• Send the default configuration file to the RCP-QE</li><li>• Load the factory defaults via DashBoard (see “<b>Loading Factory Defaults Using DashBoard</b>” on page 4–32).</li></ul>
The RCP-QE is not switching correctly.	The NK Series devices are not set up correctly to operate with or without virtual routing.	Use DashBoard to set up the devices with virtual routing enabled or disabled as required (see “ <b>Setting Up Virtual Routing and Resource Management</b> ” on page 4–30).



# RCP-QE Hexadecimal to Router Level Conversion

The router level is represented by eight hexadecimal characters. For each hexadecimal character, read the corresponding binary representation across the table.

For each '1' that appears in the binary representation, drop down to the Level row to read the actual router level included in the mask. For example, 0AB50221 represents levels 28, 26, 24, 22, 21, 19, 17, 10, 6, and 1.

**Table 7.1 Look-up table for hexadecimal to router level conversion**

Hexadecimal	1st character				2nd character				3rd character				4th character			
0	0	0	0	0	0	0	0	0	0	0	0	0	0	0	0	0
1	0	0	0	1	0	0	0	1	0	0	0	1	0	0	0	1
2	0	0	1	0	0	0	1	0	0	0	1	0	0	0	1	0
3	0	0	1	1	0	0	1	1	0	0	1	1	0	0	1	1
4	0	1	0	0	0	1	0	0	0	1	0	0	0	1	0	0
5	0	1	0	1	0	1	0	1	0	1	0	1	0	1	0	1
6	0	1	1	0	0	1	1	0	0	1	1	0	0	1	1	0
7	0	1	1	1	0	1	1	1	0	1	1	1	0	1	1	1
8	1	0	0	0	1	0	0	0	1	0	0	0	1	0	0	0
9	1	0	0	1	1	0	0	1	1	0	0	1	1	0	0	1
A	1	0	1	0	1	0	1	0	1	0	1	0	1	0	1	0
B	1	0	1	1	1	0	1	1	1	0	1	1	1	0	1	1
C	1	1	0	0	1	1	0	0	1	1	0	0	1	1	0	0
D	1	1	0	1	1	1	0	1	1	1	0	1	1	1	0	1
E	1	1	1	0	1	1	1	0	1	1	1	0	1	1	1	0
F	1	1	1	1	1	1	1	1	1	1	1	1	1	1	1	1
<b>Level</b>	<b>32</b>	<b>31</b>	<b>30</b>	<b>29</b>	<b>28</b>	<b>27</b>	<b>26</b>	<b>25</b>	<b>24</b>	<b>23</b>	<b>22</b>	<b>21</b>	<b>20</b>	<b>19</b>	<b>18</b>	<b>17</b>
Hexadecimal	5th character				6th character				7th character				8th character			
0	0	0	0	0	0	0	0	0	0	0	0	0	0	0	0	0
1	0	0	0	1	0	0	0	1	0	0	0	1	0	0	0	1
2	0	0	1	0	0	0	1	0	0	0	1	0	0	0	1	0
3	0	0	1	1	0	0	1	1	0	0	1	1	0	0	1	1
4	0	1	0	0	0	1	0	0	0	1	0	0	0	1	0	0
5	0	1	0	1	0	1	0	1	0	1	0	1	0	1	0	1
6	0	1	1	0	0	1	1	0	0	1	1	0	0	1	1	0
7	0	1	1	1	0	1	1	1	0	1	1	1	0	1	1	1
8	1	0	0	0	1	0	0	0	1	0	0	0	1	0	0	0
9	1	0	0	1	1	0	0	1	1	0	0	1	1	0	0	1
A	1	0	1	0	1	0	1	0	1	0	1	0	1	0	1	0
B	1	0	1	1	1	0	1	1	1	0	1	1	1	0	1	1
C	1	1	0	0	1	1	0	0	1	1	0	0	1	1	0	0
D	1	1	0	1	1	1	0	1	1	1	0	1	1	1	0	1
E	1	1	1	0	1	1	1	0	1	1	1	0	1	1	1	0
F	1	1	1	1	1	1	1	1	1	1	1	1	1	1	1	1
<b>Level</b>	<b>16</b>	<b>15</b>	<b>14</b>	<b>13</b>	<b>12</b>	<b>11</b>	<b>10</b>	<b>9</b>	<b>8</b>	<b>7</b>	<b>6</b>	<b>5</b>	<b>4</b>	<b>3</b>	<b>2</b>	<b>1</b>

